

# Level Measurement

## SITRANS LVL200

### Overview



SITRANS LVL200 is a standard vibrating level switch for use in liquid and slurry applications such as overflow, high, low, and demand applications, as well as pump protection. For use in SIL-2 applications.

### Benefits

- Proven vibrating level switch technology for liquids
- Compact insertion length of 40 mm (1.57") for confined space applications
- Fault monitoring for corrosion, loss of vibration or line break to the piezo drive
- SIL-2 qualified for high level and dry run applications
- Hygienic process connections

### Application

SITRANS LVL200 is a level switch designed for industrial use in all areas of process technology and can be used with liquids and slurries. With a tuning fork insertion length of only 40 mm (1.57"), SITRANS LVL200 can be mounted in small pipes and applications with confined space. The LVL200 can be used to measure products with a minimum density of  $> 0.5 \text{ g/cm}^3$  (0.018 lbs/in<sup>3</sup>). The LVL200 can be used in difficult conditions including turbulence, air bubbles, foam generation, buildup, or strong external vibration.

SITRANS LVL200 continuously monitors faults via frequency evaluation, providing early detection of strong corrosion or damage on the tuning fork, loss of vibration, or a line break to the piezo drive.

The tuning fork is piezoelectrically energized and vibrates at its mechanical resonance frequency of approx. 1200 Hz. The vibration frequency changes when the tuning fork is covered by the medium. This change is detected by the integrated oscillator and converted into a switching command. The integrated electronics evaluate the level signal and output a switching signal, directly operating connected devices.

- Key Applications: For use in liquids and slurries, for level measurement, overflow, and dry run protection

### Configuration

#### Horizontal mounting

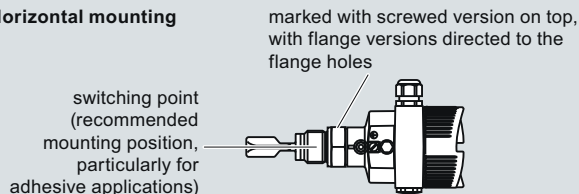

#### Vertical mounting

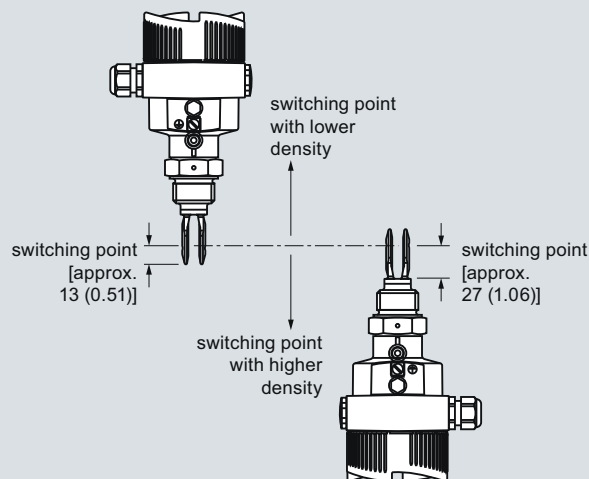

Mount away from filling openings or agitators.

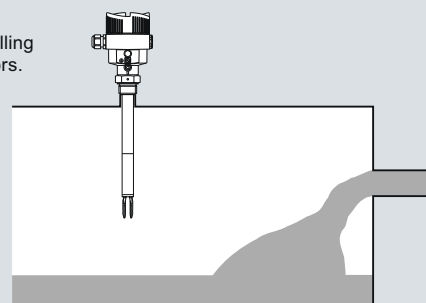

#### Moisture protection

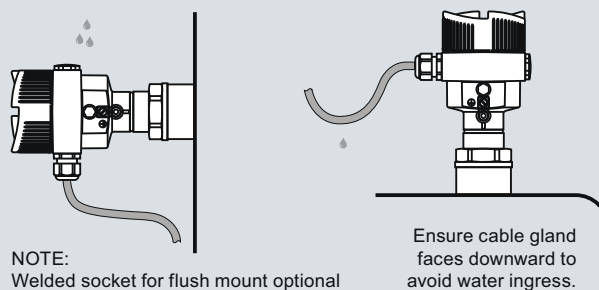

SITRANS LVL200 installation, dimensions in mm (inch)

## Technical specifications

### Mode of operation

Measuring principle Vibrating point level switch

### Input

Measured variable High and low and demand (via mode switch)

### Output

Output options

- Relay output (DPDT), 2 floating SPDTs
- Contactless electronic switch

### Measuring Accuracy

Repeatability 0.1 mm (0.004")  
 Hysteresis approx. 2 mm (0.08") with vertical installation  
 Switching delay approx. 500 ms (on/off)  
 Frequency approx. 1200 Hz

### Rated operating conditions

Installation conditions

- Location Indoor/outdoor

Ambient conditions

- Ambient temperature -40 ... +70 °C (-40 ... +158 °F)
- Installation category III
- Pollution degree 2

Medium conditions

- Temperature
  - LVL200S Standard -50 ... +150 °C (-58 ... +302 °F)
  - LVL200S High temperature option -50 ... +250 °C (-58 ... +482 °F)
  - LVL200E Standard: with 316L/Hastelloy -50 ... +150 °C (-58 ... +302 °F)
  - LVL200E High temperature option: with 316L/Hastelloy -50 ... +250 °C (-58 ... +482 °F)
- Pressure (vessel) -1 ... 64 bar g (-14.5 ... 928 psi g)
- Density 0.7 ... 2.5 g/cm<sup>3</sup>  
(0.025 ... 0.09 lbs/in<sup>3</sup>);  
0.5 ... 2.5 g/cm<sup>3</sup>  
(0.018 ... 0.09 bs/in<sup>3</sup>)  
by switching over

### Design

Material

- Enclosure Aluminum die-cast AlSi10Mg, powder-coated, basis: Polyester
- Tuning fork 316L (1.4404 or 1.4435), Hastelloy
- Extension tube [ø 21.3 mm (0.839")]
- Process connection: threaded 316L (1.4404 or 1.4435), Hastelloy
- Process connection: flange 316L (1.4404 or 1.4435), 316L with Hastelloy, ECTFE, or PFA coating
- Process seal Klingersil C-4400

### Process connection

• Pipe thread, cylindrical (ISO 228 T1) G ¾" A, G 1" A

• Pipe thread, tapered ¾" NPT, 1" NPT, 1½" NPT

• Flanges DIN from DN25, ANSI from 1"

• Hygienic fittings Bolting DN40 PN40, 1, 1½, 2, 2½" Tri-Clamp PN 10, conus DN25 PN 40, Tuchenhagen Varivent DN50 PN10, SMS

### Degree of protection

Conduit entry Type 4X/NEMA 4X/IP66/IP67

- 1 x M20x1.5 (cable: ø5 ... 9 mm), 1 x blind stopper M20x1.5; attached 1 x M20x1.5 cable entry
- 1 x ½" NPT cable entry, 1 x blind stopper ½"NPT, 1 x ½" NPT cable entry
- 1 x M12x1; 1 x blind stopper M20x1.5

### Weight

• Device weight (dependent on process fitting) approx. 0.8 ... 4 kg (0.18 ... 8.82 lbs)

• Tube extension (extended version) approx 920 g/m (10 oz/ft)

### Power supply

Supply voltage

- Relay DPDT 20 ... 253 V AC, 50/60 Hz, 20 ... 72 V DC [at U>60 V DC, the ambient temperature can be max. +50 °C (+122 °F)]
- Contactless - 20 ... 253 V AC, 50/60 Hz, 20 ... 253 V DC

Power consumption

- Relay DPDT 1 ... 8 VA (AC), approx. 1.3 W (DC)
- Relay DPDT 1 ... 8 VA (AC), approx. 1.3 W (DC)
- Contactless Domestic current requirement approx. 3 mA (via load circuit)

Load current

- Min. 10 mA
- Max. 400 mA [with I > 300 mA the ambient temperature can be max. +60 °C (+140 °F)]
- Max. 4 A up ... 40 ms (not WHG specified)

### Certificates and approvals

- CE, CSA
- Overfill protection (WHG)
- FM (Non-Incendive) Class I, Div. 2, Groups A, B, C, D
- FM (Explosion-Proof) Class I, Div. 1, Groups A, B, C, D; (Dust Ignition-Proof) Class II, III, Div. 1, Groups E, F, G1)
- IECEx d IIC T6...T2 Ga/Gb EHEDG
- ATEX II 1/2G, 2G EEx d IIC T6
- Shipping approvals: ABS, DNV, LR, RINA, GL, CCS
- SIL/IEC61508 Declaration of Conformity [SIL-2 (overfill)]

# Level Measurement

## SITRANS LVL200

### Selection and Ordering data

Order No.

#### SITRANS LVL200, Standard

Compact vibrating level switch for use in liquid and slurry applications such as overflow, high, low and demand applications, as well as pump protection. For use in SIL-2 and hazardous applications.

#### Electronics

Contactless electronic switch 20...250 V AC/DC  
Double relay (DPDT) 20 ... 72 V DC/20 ... 250 V AC  
NAMUR signal<sup>1)</sup>

#### Approvals

Without approvals  
Overfill protection (WHG)  
ATEX II 1G, 1/2G, 2G EEx ia IIC T6 + WHG<sup>2)</sup>  
ATEX II 1/2G, 2G EEx d IIC T6 + WHG<sup>3)</sup>  
ATEX II 1G, 1/2G, 2G EEx ia IIC T6 + shipping approvals<sup>2)</sup>  
ATEX II 1/2G, 2G EEx d IIC T6 + shipping approvals<sup>3)</sup>  
ATEX II 1G, 1/2G, 2G EEx ia IIC T6 + ATEX II 1/2 D IP6X T<sup>2)</sup>  
Shipping approvals  
FM (XP) Class I, Div. 1, Groups A, B, C, D; (DIP) Class II, III, Div. 1, Groups E, F, G<sup>3) 4)</sup>  
FM (NI) Class I, Div. 2, Groups A, B, C, D<sup>4)</sup>  
IECEX d IIC T6...T2 Ga/Gb  
CSA(XP)CL I,II,III DIV 1,GP A B C D E F G  
CSA(NI)CL I,II,III, DIV 2,GP A B C D E F G

#### Process connection

Thread G $\frac{3}{4}$ " A, PN64/316L A 0 0  
Thread G $\frac{3}{4}$ " A, PN64/316L Ra < 0.8 µm A 0 1  
Thread  $\frac{3}{4}$ " NPT, PN64/316L A 0 2  
Thread  $\frac{3}{4}$ " NPT, PN64/316L Ra < 0.8 µm A 0 3  
Thread  $\frac{3}{4}$ " NPT, PN64/Monel A 0 4  
Thread G $\frac{3}{4}$ " A, PN64/Hastelloy A 0 5  
Thread  $\frac{3}{4}$ " NPT, PN64/Hastelloy A 0 6  
Thread G1" A, PN64/316L A 0 7  
Thread G1" A, PN64/316L ECTFE coated MB1982<sup>5)</sup> A 0 8  
Thread G1" A, PN64/316L PFA coated<sup>5)</sup> A 1 0  
Thread G1" A, PN64/Monel A 1 1  
Thread G1" A, PN64/316L Ra < 0.8 µm A 1 2  
Thread 1" NPT, PN64/316L A 1 3  
Thread 1" NPT, PN64/316L ECTFE coated MB1982<sup>5)</sup> A 1 4  
Thread 1" NPT, PN64/316L PFA-coated<sup>5)</sup> A 1 5  
Thread 1" NPT, PN64/Monel A 1 6  
Thread 1" NPT, PN64/316L Ra < 0.8 µm A 1 7  
Thread G1" A, PN64/Hastelloy A 1 8  
Thread G1" A, PN64/Hastelloy A 2 0  
Thread G1 $\frac{1}{2}$ " A, PN64/316L A 2 1  
Thread G1 $\frac{1}{2}$ " A, PN64/316L Ra<0,8µm A 2 2  
Thread G1 $\frac{1}{2}$ " A, PN64/Hastelloy A 2 3  
Thread 1" NPT, PN64/Hastelloy A 2 4  
Thread 1 $\frac{1}{2}$ " NPT, PN64/316L A 2 5  
Thread 1 $\frac{1}{2}$ " NPT, PN64/316L Ra<0,8µm A 2 6  
Thread 1 $\frac{1}{2}$ " NPT, PN64/Hastelloy A 2 7  
Thread G2" A, PN64/316L A 2 8  
Thread M27x1.5, PN64/316L A 3 0  
Conus DN25, PN40/316L Ra < 0.3 µm A 3 1  
Conus DN25, PN40/316L Ra < 0.8 µm A 3 2  
Conus DN25, PN40/ECTFE (ZB3033)<sup>5)</sup> A 3 3  
Conus M52, PN40/316L A 3 4  
Conus M52, PN40/316L Ra < 0.3 µm A 3 5  
Conus M52, PN40/316L Ra < 0.8 µm A 3 6  
Tri-Clamp 1", PN16/316L Ra < 0.3 µm A 3 7  
Tri-Clamp 1", PN16/Hastelloy A 3 8  
Tri-Clamp 1", PN16 DIN 32676/316L Ra < 0.8 µm A 4 0  
Tri-Clamp 1 $\frac{1}{2}$ ", PN16/316L Ra < 0.3 µm A 4 1  
Tri-Clamp 1 $\frac{1}{2}$ ", PN16/Hastelloy A 4 2

7 M L 5 7 4 6 -  
- A 0

### Selection and Ordering data

Order No.

#### SITRANS LVL200, Standard

Compact vibrating level switch for use in liquid and slurry applications such as overflow, high, low and demand applications, as well as pump protection. For use in SIL-2 and hazardous applications.

Tri-Clamp 1 $\frac{1}{2}$ ", PN16/316L Ra < 0.8 µm A 4 3  
Tri-Clamp 2", PN16/316L Ra < 0.3 µm A 4 4  
Tri-Clamp 2", PN16/Hastelloy A 4 5  
Tri-Clamp 2", PN16/316L Ra < 0.8 µm A 4 6  
Tri-Clamp 2 $\frac{1}{2}$ ", PN10/316L Ra < 0.3 µm A 4 7  
Tri-Clamp 2 $\frac{1}{2}$ ", PN10/316L Ra < 0.8 µm A 4 8

Tri-Clamp 3", PN10/316L Ra < 0.3 µm A 5 0  
Tri-Clamp 3", PN10/316L Ra < 0.8 µm A 5 1  
Bolting DN32, PN40 DIN11851/316L Ra < 0.3 µm A 5 2  
Bolting DN32, PN40 DIN11851/316L Ra < 0.8 µm A 5 3  
Bolting DN25, PN40 DIN11851/316L Ra < 0.3 µm A 5 4  
Bolting DN25, PN40 DIN11851/316L Ra < 0.8 µm A 5 5  
Bolting DN40, PN40 DIN11851/316L Ra < 0.3 µm A 5 6  
Bolting DN40, PN40 DIN11851/316L Ra < 0.8 µm A 5 7  
Bolting DN 40, PN40 DIN11864-1 A/316L Ra < 0.8 µm ZB3052 A 5 8

Bolting DN50, PN25 DIN11851/316L Ra < 0.3 µm A 6 0  
Bolting DN50, PN25 DIN11851/316L Ra < 0.8 µm A 6 1  
Bolting DN50, PN25 DIN11864-1 A/316L Ra < 0.8 µm ZB3052 A 6 2

Hygienic w. compr. nut F40, PN25/316L A 6 3  
Hygienic w. compr. nut F40, PN25/316L Ra < 0.3 µm A 6 4  
Hygienic w. compr. nut F40, PN25/316L Ra < 0.8 µm A 6 5

Varivent N50-40/316L Ra < 0.3 µm A 6 6  
Varivent N50-40/316L Ra < 0.8 µm A 6 7  
Varivent N125/100/316L Ra < 0.8 µm A 6 8

DRD flange, PN40/316L ZB3007 A 7 0  
SMS DN38/316L Ra < 0.8 µm<sup>5)</sup> A 7 1  
SMS DN51, PN6/316L Ra < 0.8 µm<sup>5)</sup> A 7 2

Swagelok VCR screwing ZG2579, PN64/316L A 7 3  
Neumo biocontrol Gr. 25, PN16/316L Ra < 0.8 µm A 7 4  
Neumo biocontrol Gr. 50, PN16/316L Ra < 0.8 µm<sup>5)</sup> A 7 5

Neumo biocontrol Gr. 65, PN16/316L Ra < 0.8 µm A 7 6  
Neumo biocontrol Gr. 80, PN16/316L Ra < 0.8 µm A 7 7  
SÜDMO DN50, PN10/316L/316L Ra<0,8µm A 7 8

Small flange DN25, PN1.5 DIN 28403/316L pol.Ra < 0.8 µm A 8 0  
Small flange DN40, PN1.5 DIN 28403/316L pol.Ra < 0.8 µm A 8 1

Ingold connection, PN16/316L Ra < 0.8 µm A 8 2

Ingold connection, PN16/Hastelloy A 8 3  
Terminal DN 33,7 PN40 DIN11864-3-A-/316L BN2 Ra < 0.8 µm<sup>5)</sup> A 8 4

Hygienic fl. DN50 PN16 DIN11864-2-A-/316L Ra < 0.8 µm A 8 5

Flange DN25, PN6 Form C, DIN 2501/316L A 8 6  
Flange DN25, PN6 Form C, DIN 2501/PFA<sup>5)</sup> A 8 7  
Flange DN25, PN40 Form C, DIN 2501/316L A 8 8

Flange DN25, PN40 Form C, DIN 2501/Hastelloy B 0 0  
Flange DN25, PN40 Form C, DIN 2501/ECTFE<sup>5)</sup> B 0 1  
Flange DN25, PN40 Form C, DIN 2501/PFA<sup>5)</sup> B 0 2

Flange DN25, PN40 Form C, DIN 2501/Enamelled B 0 3  
Flange DN25, PN40 Form D, DIN 2501/316L B 0 4  
Flange DN25, PN40 Form F, DIN 2501/316L B 0 5

Flange DN25, PN40 Form N, DIN 2501/316L B 0 6  
Flange DN25, PN40 Form N, DIN 2501/Hastelloy B 0 7  
Flange DN25, PN40 Form N, DIN 2501/Monel solid B 0 8

Flange DN25, PN40 V13, DIN 2501/316L B 1 0  
Flange DN32, PN40 Form C, DIN 2501/316L B 1 1  
Flange DN32, PN40 Form C, DIN 2501/ECTFE<sup>5)</sup> B 1 2

7 M L 5 7 4 6 -  
- A 0

Selection and Ordering data	Order No.	Selection and Ordering data	Order No.
<b>SITRANS LVL200, Standard</b> Compact vibrating level switch for use in liquid and slurry applications such as overflow, high, low and demand applications, as well as pump protection. For use in SIL-2 and hazardous applications.	<b>7 M L 5 7 4 6 -</b> A 0	<b>SITRANS LVL200, Standard</b> Compact vibrating level switch for use in liquid and slurry applications such as overflow, high, low and demand applications, as well as pump protection. For use in SIL-2 and hazardous applications.	<b>7 M L 5 7 4 6 -</b> A 0
Flange DN40, PN6 Form C, DIN 2501/316L	<b>B 13</b>	Flange DN100, PN40 Form F, DIN 2501/316L	<b>B 75</b>
Flange DN40, PN6 Form C, DIN 2501/ECTFE <sup>5)</sup>	<b>B 14</b>	Flange DN100, PN40 Form N, DIN 2501/316L	<b>B 76</b>
Flange DN40, PN40 Form C, DIN 2501/316L	<b>B 15</b>	Flange DN100, PN40 V13, DIN 2501/316L	<b>B 77</b>
Flange DN40, PN40 Form C, DIN 2501/Hastelloy	<b>B 16</b>	Flange DN100, PN64 Form E, DIN 2501/316L	<b>B 78</b>
Flange DN40, PN40 Form C, DIN 2501/ECTFE <sup>5)</sup>	<b>B 17</b>	Flange DN100, PN100 Form E, DIN 2501/316L	<b>B 80</b>
Flange DN40, PN40 Form C, DIN 2501/PFA <sup>5)</sup>	<b>B 18</b>	Flange DN100, PN100 Form L, DIN 2501/316L	<b>B 81</b>
Flange DN40, PN40 Form C, DIN 2501/Enamelled <sup>6)</sup>	<b>B 20</b>	Flange DN125, PN16 Form F, DIN 2501/316L	<b>B 82</b>
Flange DN40, PN40 Form F, DIN 2501/316L	<b>B 21</b>	Flange DN125, PN40 Form C, DIN 2501/316L	<b>B 83</b>
Flange DN40, PN40 Form N, DIN 2501/316L	<b>B 22</b>	Flange DN125, PN40 Form N, DIN 2512/ 316L	<b>B 84</b>
Flange DN40, PN40 Form E, DIN 2501/316L	<b>B 23</b>	Flange DN150, PN16 Form C, DIN 2501/316L	<b>B 85</b>
Flange DN40, PN40 V13, DIN 2501/316L	<b>B 24</b>	Flange DN150, PN16 Form C, DIN 2501/Hastelloy	<b>B 86</b>
Flange DN50, PN40 Form C, DIN 2501/316L	<b>B 25</b>	Flange DN150, PN16 Form C, DIN 2501/ECTFE <sup>5)</sup>	<b>B 87</b>
Flange DN50, PN40 Form C, DIN 2501/Hastelloy	<b>B 26</b>	Flange DN150, PN16 Form C, DIN 2501/PFA <sup>5)</sup>	<b>B 88</b>
Flange DN50, PN40 Form C, DIN 2501/ECTFE <sup>5)</sup>	<b>B 27</b>	Flange DN150, PN16 Form D, DIN 2501/316L	<b>C 00</b>
Flange DN50, PN40 Form C, DIN 2501/ECTFE (ZB3108) <sup>5)</sup>	<b>B 28</b>	Flange DN150, PN40 Form C, DIN 2501/316L	<b>C 01</b>
Flange DN50, PN40 Form C, DIN 2501/PFA <sup>5)</sup>	<b>B 30</b>	Flange DN150, PN40 Form C, DIN 2501/Hastelloy	<b>C 02</b>
Flange DN50, PN40 Form D, DIN 2501/316L	<b>B 31</b>	Flange DN150, PN40 Form F, DIN 2501/316L	<b>C 03</b>
Flange DN50, PN40 Form D, DIN 2501/Hastelloy	<b>B 32</b>	Flange DN150, PN40 Form N, DIN 2512/316L	<b>C 04</b>
Flange DN50, PN40 Form F, DIN 2501/316L	<b>B 33</b>	Flange DN200, PN10 Form C, DIN 2501/ECTFE <sup>5)</sup>	<b>C 05</b>
Flange DN50, PN40 Form N, DIN 2501/316L	<b>B 34</b>	Flange DN200, PN16 Form C, DIN 2501/316L	<b>C 06</b>
Flange DN50, PN40 Form N, DIN 2501/Hastelloy	<b>B 35</b>	Flange DN25, PN40 Form B1, EN 1092-1/316L	<b>C 07</b>
Flange DN50, PN40 Form E, DIN 2501/316L	<b>B 36</b>	Flange DN25, PN40 Form B1, EN 1092-1/Hastelloy	<b>C 08</b>
Flange DN50, PN40 V13, DIN 2501/316L	<b>B 37</b>	Flange DN25, PN40 Form B1, EN/ 316L/ PFA <sup>5)</sup>	<b>C 10</b>
Flange DN50, PN40 R13, DIN 2501/316L	<b>B 38</b>	Flange DN25, PN40 Form B1, EN 1092-1/ Enamelled <sup>6)</sup>	<b>C 11</b>
Flange DN50, PN64 Form F, DIN 2501/316L	<b>B 40</b>	Flange DN25, PN40 Form B2, EN 1092-1/316L	<b>C 12</b>
Flange DN50, PN64 Form N, DIN 2501/Hastelloy	<b>B 41</b>	Flange DN25, PN40 Form F, EN 1092-1/316L	<b>C 13</b>
Flange DN50, PN64 Form C, DIN 2501/316L	<b>B 42</b>	Flange DN25, PN63 Form B1, EN 1092-1/316L	<b>C 14</b>
Flange DN50, PN64 Form L, DIN 2501/316L	<b>B 43</b>	Flange DN25, PN100 Form B2, EN 1092-1/316L	<b>C 15</b>
Flange DN50, PN100 Form E, DIN 2501/316L	<b>B 44</b>	Flange DN40, PN40 Form B1, EN/ 316L	<b>C 16</b>
Flange DN50, PN100 Form L, DIN 2501/316L	<b>B 45</b>	Flange DN40, PN40 Form B1, EN 1092-1/PFA <sup>5)</sup>	<b>C 17</b>
Flange DN65, PN40 Form C, DIN 2501/316L	<b>B 46</b>	Flange DN40, PN40 Form B2, EN/316L	<b>C 18</b>
Flange DN65, PN40 Form C, DIN 2501/Hastelloy	<b>B 47</b>	Flange DN50, PN40 Form B1, EN/316L	<b>C 20</b>
Flange DN65, PN40 Form C, DIN 2501/ECTFE <sup>5)</sup>	<b>B 48</b>	Flange DN50, PN40 Form B1, EN 1092-1/Hastelloy	<b>C 21</b>
Flange DN65, PN40 Form C, DIN 2501/PFA <sup>5)</sup>	<b>B 50</b>	Flange DN50, PN40 Form B1, EN 1092-1/ Monel ZB2977	<b>C 22</b>
Flange DN65, PN40 Form F, DIN 2501/316L	<b>B 51</b>	Flange DN50, PN40 Form B1, EN 1092-1/ECTFE <sup>5)</sup>	<b>C 23</b>
Flange DN65, PN64 Form E, DIN 2501/316L	<b>B 52</b>	Flange DN50, PN40 Form B1, EN/ 316L/PFA <sup>5)</sup>	<b>C 24</b>
Flange DN80, PN40 Form C, DIN 2501/316L	<b>B 53</b>	Flange DN50, PN40 Form B1, EN 1092-1/ Enamelled <sup>6)</sup>	<b>C 25</b>
Flange DN80, PN40 Form C, DIN 2501/ Hastelloy	<b>B 54</b>	Flange DN50, PN40 Form C, EN 1092-1/316L	<b>C 26</b>
Flange DN80, PN40 Form C, DIN 2501/ECTFE <sup>5)</sup>	<b>B 55</b>	Flange DN50, PN40 Form D, EN/316L	<b>C 27</b>
Flange DN80, PN40 Form C, DIN 2501/PFA <sup>5)</sup>	<b>B 56</b>	Flange DN50, PN40 Form D, EN 1092-1/Hastelloy	<b>C 28</b>
Flange DN80, PN40 Form C, DIN 2501/Enamelled <sup>6)</sup>	<b>B 57</b>	Flange DN50, PN40 Form B2, EN 1092-1/316L	<b>C 30</b>
Flange DN80, PN40 Form F, DIN 2501/316L	<b>B 58</b>	Flange DN50, PN40 Form E, EN 1092-1/316L	<b>C 31</b>
Flange DN80, PN40 Form N, DIN 2501/316L	<b>B 60</b>	Flange DN80, PN40 Form B1, EN 1092-1/316L	<b>C 32</b>
Flange DN80, PN40 Form N, DIN 2501/Hastelloy	<b>B 61</b>	Flange DN80, PN40 Form B1, EN 1092-1/Hastelloy	<b>C 33</b>
Flange DN100, PN16 Form C, DIN 2501/316L	<b>B 62</b>	Flange DN80, PN40 Form B1, EN 1092-1/ECTFE <sup>5)</sup>	<b>C 34</b>
Flange DN100, PN16 Form C, DIN 2501/Hastelloy	<b>B 63</b>	Flange DN80, PN40 Form B1, EN 1092-1/ Enamelled <sup>6)</sup>	<b>C 35</b>
Flange DN100, PN16 Form C, DIN 2501/ECTFE <sup>5)</sup>	<b>B 64</b>	Flange DN80, PN40 Form B2, EN 1092-1/316L	<b>C 36</b>
Flange DN100, PN16 Form C, DIN 2501/PFA <sup>5)</sup>	<b>B 65</b>	Flange DN100, PN16 Form B1, EN 1092-1/316L	<b>C 37</b>
Flange DN100, PN16 Form C, DIN 2501/Enamelled <sup>6)</sup>	<b>B 66</b>	Flange DN100, PN16 Form B1, EN 1092-1/ Hastelloy	<b>C 38</b>
Flange DN100, PN16 Form D, DIN 2501/316L	<b>B 67</b>	Flange DN100, PN16 Form B1, EN 1092-1/ Enamelled <sup>6)</sup>	<b>C 40</b>
Flange DN100, PN16 Form F, DIN 2501/316L	<b>B 68</b>	Flange DN100, PN40 Form B1, EN 1092-1/316L	<b>C 41</b>
Flange DN100, PN16 Form N, DIN 2501/316L	<b>B 70</b>	Flange DN100, PN40 Form B1, EN 1092-1/ Enamelled <sup>6)</sup>	<b>C 42</b>
Flange DN100, PN40 Form C, DIN 2501/316L	<b>B 71</b>	Flange DN100, PN40 Form C, EN 1092-1/316L	<b>C 43</b>
Flange DN100, PN40 Form C, DIN 2501/ECTFE <sup>5)</sup>	<b>B 72</b>	Flange DN100, PN63 Form B2, EN 1092-1/316L	<b>C 44</b>
Flange DN100, PN40 Form C, DIN 2501/PFA <sup>5)</sup>	<b>B 73</b>	Flange DN150, PN16 Form B1, EN 1092-1/316L	<b>C 45</b>
Flange DN100, PN40 Form C, DIN 2501/Enamelled <sup>6)</sup>	<b>B 74</b>		

# Level Measurement

## SITRANS LVL200

### Selection and Ordering data

Order No.

#### SITRANS LVL200, Standard

Compact vibrating level switch for use in liquid and slurry applications such as overflow, high, low and demand applications, as well as pump protection. For use in SIL-2 and hazardous applications.

 7 M L 5 7 4 6 -  

 A 0

Flange DN150, PN16 Form B1, EN 1092-1/PFA <sup>5)</sup>	C 4 6
Flange DN150, PN40 Form B1, EN 1092-1/316L	C 4 7
Flange DN150, PN40 Form B1, EN 1092-1/ECTFE <sup>5)</sup>	C 4 8
Flange DN150, PN40 Form B2, EN 1092-1/316L	C 5 0
Flange 1" 150lb ANSI B16.5/316L	C 5 1
Flange 1" 150lb RF, ANSI B16.5/Hastelloy	C 5 2
Flange 1" 150lb RF, ANSI B16.5/Monel ZB2977	C 5 3
Flange 1" 150lb RF, ANSI B16.5/ECTFE <sup>5)</sup>	C 5 4
Flange 1" 150lb RF, ANSI B16.5/PFA <sup>5)</sup>	C 5 5
Flange 1" 150lb RF, ANSI B16.5/Enamelled <sup>6)</sup>	C 5 6
Flange 1" 300lb RF, ANSI B16.5/316L	C 5 7
Flange 1" 300lb RF, ANSI B16.5/ECTFE <sup>5)</sup>	C 5 8
Flange 1" 600lb RF, ANSI B16.5/316L	C 6 0
Flange 1½" 150lb RF, ANSI B16.5/316L	C 6 1
Flange 1½" 150lb RF, ANSI B16.5/Hastelloy	C 6 2
Flange 1½" 150lb RF, ANSI B16.5/ECTFE <sup>5)</sup>	C 6 3
Flange 1½" 150lb RF, ANSI B16.5/PFA <sup>5)</sup>	C 6 4
Flange 1½" 150lb RF, ANSI B16.5 Enamelled <sup>6)</sup>	C 6 5
Flange 1½" 150lb FF, ANSI B16.5/ECTFE <sup>5)</sup>	C 6 6
Flange 1½" 300lb RF, ANSI B16.5/316L	C 6 7
Flange 1½" 300lb RF, ANSI B16.5/Monel ZB2977	C 6 8
Flange 1½" 300lb RF, ANSI B16.5/ECTFE <sup>6)</sup>	C 7 0
Flange 1½" 600lb RF, ANSI B16.5/316L	C 7 1
Flange 2" 150lb RF, ANSI B16.5/316L	C 7 2
Flange 2" 150lb RF, ANSI B16.5/Hastelloy	C 7 3
Flange 2" 150lb RF, ANSI B16.5/Monel ZB2977	C 7 4
Flange 2" 150lb RF, ANSI B16.5/ECTFE <sup>5)</sup>	C 7 5
Flange 2" 150lb RF, ANSI B16.5/PFA <sup>5)</sup>	C 7 6
Flange 2" 150lb RF, ANSI B16.5/Enamelled <sup>6)</sup>	C 7 7
Flange 2" 150lb FF, ANSI B16.5/316L	C 7 8
Flange 2" 150lb FF, ANSI B16.5/ECTFE <sup>5)</sup>	C 8 0
Flange 2" 150lb SG (small groove), ANSI B16.5/316L	C 8 1
Flange 2" 300lb RF, ANSI B16.5/316L	C 8 2
Flange 2" 300lb RF, ANSI B16.5/Hastelloy	C 8 3
Flange 2" 300lb RF, ANSI B16.5/Hastelloy	C 8 4
Flange 2" 300lb RF, ANSI B16.5/ECTFE <sup>5)</sup>	C 8 5
Flange 2" 300lb RF, ANSI B16.5/PFA <sup>5)</sup>	C 8 6
Flange 2" 300lb RF, ANSI B16.5 Enamelled <sup>6)</sup>	C 8 7
Flange 2" 300lb RJF, ANSI B16.5/316L	C 8 8
Flange 2" 300lb ST, ANSI B16.5/316L	D 0 0
Flange 2" 300lb LG (large groove), ANSI B16.5/316L	D 0 1
Flange 2" 300lb LT, ANSI B16.5/316L	D 0 2
Flange 2" 600lb RF, ANSI B16.5/316L	D 0 3
Flange 2" 600lb RF, ANSI B16.5/Monel ZB2977	D 0 4
Flange 2" 600lb RF, ANSI B16.5/ECTFE <sup>5)</sup>	D 0 5
Flange 2" 600lb RJF, ANSI B16.5/316L	D 0 6
Flange 2" 600lb LG, ANSI B16.5/316L	D 0 7
Flange 2" 900lb RJF, ANSI B16.5/316L	D 0 8
Flange 2½" 150lb RF, ANSI B16.5/316L	D 1 0
Flange 2½" 300lb RF, ANSI B16.5/316L	D 1 1
Flange 3" 150lb RF, ANSI B16.5/316L	D 1 2
Flange 3" 150lb RF, ANSI B16.5/Hastelloy	D 1 3
Flange 3" 150lb RF, ANSI B16.5/ECTFE <sup>5)</sup>	D 1 4
Flange 3" 150lb RF, ANSI B16.5/PFA <sup>5)</sup>	D 1 5
Flange 3" 150lb RF, ANSI B16.5/Enamelled <sup>6)</sup>	D 1 6
Flange 3" 150lb FF, ANSI B16.5/316L	D 1 7
Flange 3" 150lb FF, ANSI B16.5/ECTFE <sup>5)</sup>	D 1 8
Flange 3" 150lb FF, ANSI B16.5/PFA <sup>5)</sup>	D 2 0
Flange 3" 300lb RF, ANSI B16.5/316L	D 2 1

### Selection and Ordering data

Order No.

#### SITRANS LVL200, Standard

Compact vibrating level switch for use in liquid and slurry applications such as overflow, high, low and demand applications, as well as pump protection. For use in SIL-2 and hazardous applications.

 7 M L 5 7 4 6 -  

 A 0

Flange 3" 300lb RF, ANSI B16.5/Hastelloy	D 2 2
Flange 3" 300lb RF, ANSI B16.5/ECTFE <sup>5)</sup>	D 2 3
Flange 3" 300lb RF, ANSI B16.5/PFA <sup>5)</sup>	D 2 4
Flange 3" 300lb RF, ANSI B16.5/Enamelled <sup>6)</sup>	D 2 5
Flange 3" 600lb RF, ANSI B16.5/316L	D 2 6
Flange 3½" 150lb RF, ANSI B16.5/316L	D 2 7
Flange 3½" 150lb RF, ANSI B16.5/ECTFE <sup>5)</sup>	D 2 8
Flange 4" 150lb RF, ANSI B16.5/316L	D 3 0
Flange 4" 150lb RF, ANSI B16.5/Hastelloy	D 3 1
Flange 4" 150lb RF, ANSI B16.5/ECTFE <sup>5)</sup>	D 3 2
Flange 4" 150lb RF, ANSI B16.5/PFA <sup>5)</sup>	D 3 3
Flange 4" 150lb RF, ANSI B16.5/Enamelled <sup>6)</sup>	D 3 4
Flange 4" 150lb LT, ANSI B16.5/316L	D 3 5
Flange 4" 300lb RF, ANSI B16.5/316L	D 3 6
Flange 4" 300lb RF, ANSI B16.5/Hastelloy	D 3 7
Flange 4" 300lb RF, ANSI B16.5/ECTFE <sup>5)</sup>	D 3 8
Flange 4" 300lb RJF, ANSI B16.5/316L	D 4 0
Flange 4" 300lb LG, ANSI B16.5/316L	D 4 1
Flange 4" 300lb LT, ANSI B16.5/316L	D 4 2
Flange 4" 600lb RF, ANSI B16.5/316L	D 4 3
Flange 4" 600lb RJF, ANSI B16.5/316L	D 4 4
Flange 6" 150lb RF, ANSI B16.5/316L	D 4 5
Flange 6" 150lb RF, ANSI B16.5/Hastelloy	D 4 6
Flange 6" 150lb RF, ANSI B16.5/ECTFE <sup>5)</sup>	D 4 7
Flange 6" 150lb RF, ANSI B16.5/PFA <sup>5)</sup>	D 4 8
Flange 6" 150lb RJF, ANSI B16.5/316L	D 5 0
Flange 6" 300lb RF, ANSI B16.5/316L	D 5 1
Flange 8" 150lb RF, ANSI B16.5/316L	D 5 2
Flange 8" 150lb RF, ANSI B16.5/ECTFE <sup>5)</sup>	D 5 3
Flange 1" BS.10 Table E/316L	D 5 4
Flange 1" BS.10 Table E/PFA <sup>5)</sup>	D 5 5
Flange 1½" BS.10 Table E/316L	D 5 6
Flange 3½" BS.10 Table E/316L	D 5 7
Flange 4" BS.10 Table E/ECTFE <sup>5)</sup>	D 5 8
Flange DN40 10K, JIS/316L	D 6 0
Flange DN50 10K, JIS/316L	D 6 1
Flange DN80 10K, JIS/316L	D 6 2
Flange DN100 10K, JIS/316L	D 6 3

#### Adapter/Process temperature

Without adapter/-50 ... +150 °C (-58 ... +302 °F)

1

With adapter/-50 ... +200 °C (-58 ... +392 °F)<sup>7)</sup>

2

With adapter/-50 ... +250 °C (-58 ... +482 °F)

3

With gas-tight leadthrough/-50 ... +150 °C (-58 ... +302 °F)

4

With gas-tight leadthrough/-50 ... +250 °C (-58 ... +482 °F)

5

#### Housing/ Cable entry

Aluminium IP66/IP67/M20x1.5

A

Aluminium IP66/IP67/½" NPT

B

- 1) Available with Approval options A to G, and K, and Adapter/Process temperature options 1, and 3 to 5 only
- 2) Available with Electronics option 4 only
- 3) Available with Adapter/Process temperature options 1 and 3 only
- 4) Available with Housing/Cable entry option B only
- 5) Available with Adapter/Process temperature options 1 and 4 only
- 6) Available with Adapter/Process temperature options 1, 2, and 4 only
- 7) Available with enamelled Process connection options only

Selection and Ordering data	Order code
<b>Further designs</b>	
Please add <b>"-Z"</b> to Order No. and specify Order code(s).	
Cleaning including Certificate (oil, grease and silicone free)	<b>W01</b>
Identification Label (measurement loop) SS: max. 16 characters add in plain text	<b>Y17</b>
Identification Label (measurement loop) Foil: max. 16 characters add in plain text	<b>Y18</b>
Acceptance test certificate 3.1 NACE MR 0775 for material EN10204	<b>D07</b>
Acceptance test certificate 3.1 for instrument EN10204	<b>C12</b>
Acceptance test certificate 2.2 for instrument EN10204	<b>C14</b>
Acceptance test Certificate 2.2 for material EN10204	<b>C15</b>
SIL/IEC61508 Certificate of conformity (SIL-2/3 min. and max. detection)	<b>C20</b>
<b>Additional Operating Instructions</b>	
<u>LVL200 (DPDT Relay)</u>	
• English	<b>7ML1998-5KR01</b>
• French	<b>7ML1998-5KR11</b>
• Spanish	<b>7ML1998-5KR21</b>
• German	<b>7ML1998-5KR31</b>
<u>LVL200 (Contactless electronic switch)</u>	
• English	<b>7ML1998-5KQ01</b>
• French	<b>7ML1998-5KQ11</b>
• Spanish	<b>7ML1998-5KQ21</b>
• German	<b>7ML1998-5KQ31</b>
<u>Electronics module LVL200 Relay</u>	
• English	<b>7ML1998-5LS01</b>
• French	<b>7ML1998-5LS11</b>
• Spanish	<b>7ML1998-5LS21</b>
• German	<b>7ML1998-5LS31</b>
This device is shipped with the Siemens Milltronics manual CD containing the complete Operating Instructions library.	
<b>Spare Parts</b>	
Electronics module SITRANS LVL200 Relay <u>LVL100 Threaded Welded Socket</u>	<b>7ML1830-1NC</b>
• G 3/4" A / 316L with FKM Seal	<b>7ML1930-1EE</b>
• G 1 A / 316L with FKM Seal	<b>7ML1930-1EF</b>
• M27x1.5 / 316L with FKM Seal	<b>7ML1930-1EG</b>
• G 3/4" A / 316L with EPDM Seal	<b>7ML1930-1EH</b>
• G 1 A / 316L with EPDM Seal	<b>7ML1930-1EJ</b>
• M27x1.5 / 316L with EPDM Seal	<b>7ML1930-1EK</b>

# Level Measurement

## SITRANS LVL200

### Selection and Ordering data

Order No.

#### SITRANS LVL200, Rigid extension

Compact vibrating level switch for use in liquid applications such as overflow, high, low and demand applications, as well as pump protection. For use in SIL-2 and hazardous applications.

#### Electronics

Contactless electronic switch 20...250 V AC/DC  
Double relay (DPDT) 20 ... 72 V DC/20 ... 250 V AC  
NAMUR signal<sup>1)</sup>

#### Approvals

Without approvals  
Overfill protection (WHG)  
ATEX II 1G, 1/2G, 2G EEx ia IIC T6 + WHG<sup>2)</sup>  
ATEX II 1/2G, 2G EEx d IIC T6 + WHG<sup>3)</sup>  
ATEX II 1G, 1/2G, 2G EEx ia IIC T6 + shipping approvals<sup>2)</sup>  
ATEX II 1/2G, 2G EEx d IIC T6 + shipping approvals<sup>3)</sup>  
ATEX II 1G, 1/2G, 2G EEx ia IIC T6 + ATEX II 1/2D IP6X T<sup>2)</sup>  
Shipping approvals  
FM (XP) Class I, Div. 1, Groups A, B, C, D; (DIP) Class II, III, Div. 1, Groups E, F, G<sup>3) 4)</sup>  
FM (NI) Class I, Div. 2, Groups A, B, C, D<sup>4)</sup>  
IECEx d IIC T6...T2 Ga/Gb  
CSA(XP)CL I,II,III DIV 1,GP A B C D E F G...T2 Ga/Gb  
CSA(NI)CL I,II,III, DIV 2,GP A B C D E F G

#### Process connection

Thread G $\frac{3}{4}$ " A, PN64/316L **A 0 0**  
Thread G $\frac{3}{4}$ " A, PN64/316L Ra < 0.8 µm **A 0 1**  
Thread  $\frac{3}{4}$ " NPT, PN64/316L **A 0 2**  
Thread  $\frac{3}{4}$ " NPT, PN64/316L Ra < 0.8 µm **A 0 3**  
Thread  $\frac{3}{4}$ " NPT, PN64/Monel **A 0 4**  
Thread G $\frac{3}{4}$ " A, PN64/Hastelloy **A 0 5**  
Thread  $\frac{3}{4}$ " NPT, PN64/Hastelloy **A 0 6**  
Thread G1" A, PN64/316L **A 0 7**  
Thread G1" A, PN64/316L ECTFE coated MB1982<sup>5)</sup> **A 0 8**  
Thread G1" A, PN64/316L PFA coated<sup>5)</sup> **A 1 0**  
Thread G1" A, PN64/Monel **A 1 1**  
Thread G1" A, PN64/316L Ra < 0.8 µm **A 1 3**  
Thread 1" NPT, PN64/316L **A 1 4**  
Thread 1" NPT, PN64/316L ECTFE coated MB1982<sup>5)</sup> **A 1 5**  
Thread 1" NPT, PN64/316L PFA coated<sup>5)</sup> **A 1 6**  
Thread 1" NPT, PN64/Monel **A 1 7**  
Thread 1" NPT, PN64/316L Ra < 0.8 µm **A 1 8**  
Thread G1" A, PN64/Hastelloy **A 2 0**  
Thread G1 $\frac{1}{2}$ " A, PN64/316L **A 2 1**  
Thread G1 $\frac{1}{2}$ " A, PN64/316L Ra < 0.8 µm **A 2 2**  
Thread G1 $\frac{1}{2}$ " A, PN64/Hastelloy **A 2 3**  
Thread 1" NPT, PN64/Hastelloy **A 2 4**  
Thread 1 $\frac{1}{2}$ " NPT, PN64/316L **A 2 5**  
Thread 1 $\frac{1}{2}$ " NPT, PN64/316L Ra < 0.8 µm **A 2 6**  
Thread 1 $\frac{1}{2}$ " NPT, PN64/Hastelloy **A 2 7**  
Thread G2" A, PN64/316L **A 2 8**  
Thread M27x1.5 PN64/316L **A 3 0**  
Cyl. socket/316Ti/1.4581 ECTFE coated ZB2984<sup>5)</sup> **A 3 1**  
Conus DN25 PN40/316L Ra < 0.3 µm **A 3 2**  
Conus DN25 PN40/316L Ra < 0.8 µm. **A 3 3**  
Conus DN25 PN40/ECTFE (ZB3033)<sup>5)</sup> **A 3 4**  
Conus M52 PN40/316L **A 3 5**  
Conus M52 PN40/316L Ra < 0.3 µm **A 3 6**  
Conus M52 PN40/316L Ra < 0.8 µm **A 3 7**  
Tri-Clamp 1" PN16 DIN 32676/316L Ra < 0.3 µm **A 3 8**  
Tri-Clamp 1" PN16/Hastelloy **A 4 0**  
Tri-Clamp 1" PN16/316L Ra < 0.8 µm **A 4 1**

### Selection and Ordering data

Order No.

#### SITRANS LVL200, Rigid extension

Compact vibrating level switch for use in liquid applications such as overflow, high, low and demand applications, as well as pump protection. For use in SIL-2 and hazardous applications.

Tri-Clamp 1 $\frac{1}{2}$ " PN16/316L Ra < 0.3 µm **A 4 2**  
Tri-Clamp 1 $\frac{1}{2}$ " PN16/Hastelloy **A 4 3**  
Tri-Clamp 1 $\frac{1}{2}$ " PN16/316L Ra < 0.8 µm **A 4 4**  
Tri-Clamp 2" PN16/316L Ra < 0.3 µm **A 4 5**  
Tri-Clamp 2" PN16/Hastelloy **A 4 6**  
Tri-Clamp 2" PN16/316L Ra < 0.8 µm **A 4 7**  
Tri-Clamp 2 $\frac{1}{2}$ " PN10/316L Ra < 0.3 µm **A 4 8**  
Tri-Clamp 2 $\frac{1}{2}$ " PN10/316L Ra < 0.8 µm **A 5 0**  
Tri-Clamp 3" PN10/316L Ra < 0.3 µm **A 5 1**  
Tri-Clamp 3" PN10/316L Ra < 0.8 µm **A 5 2**

Bolting DN32 PN40 DIN11851/316L Ra < 0.3 µm **A 5 3**  
Bolting DN32 PN40 DIN11851/316L Ra < 0.8 µm **A 5 4**  
Bolting DN25 PN40 DIN11851/316L Ra < 0.3 µm **A 5 5**

Bolting DN25 PN40 DIN11851/316L Ra < 0.8 µm **A 5 6**  
Bolting DN40 PN40 DIN11851/316L Ra < 0.3 µm **A 5 7**  
Bolting DN40 PN40 DIN11851/316L Ra < 0.8 µm **A 5 8**

Bolting DN40 PN40 DIN11864-1 A/316L Ra < 0.8 µm ZB3052 **A 6 0**

Bolting DN50 PN25 DIN11851/316L Ra < 0.3 µm **A 6 1**  
Bolting DN50 PN25 DIN11851/316L Ra < 0.8 µm **A 6 2**

Bolting DN50 PN25 DIN11864-1 A/316L Ra < 0.8 µm ZB3052 **A 6 3**

Hygienic w.compr.nut F40 PN25/316L **A 6 4**

Hygienic w.compr.nut F40 PN25/316L Ra < 0.3 µm **A 6 5**

Hygienic w.compr.nut F40 PN25/316L Ra < 0.8 µm **A 6 6**

Varivent N50-40/316L Ra < 0.3 µm **A 6 7**

Varivent N50-40/316L Ra < 0.8 µm **A 6 8**

Varivent N125/100/316L Ra < 0.8 µm **A 7 0**

DRD flange PN40/316L ZB3007 **A 7 1**

SMS DN38/316L Ra < 0.8 µm<sup>5)</sup> **A 7 2**

SMS DN51 PN6/316L Ra < 0.8 µm<sup>5)</sup> **A 7 3**

Swagelok VCR screwing ZG2579 PN64/316L **A 7 4**

Neumo biocontrol Gr.25 PN16/316L Ra < 0.8 µm **A 7 5**

Neumo biocontrol Gr.50 PN16/316L Ra < 0.8 µm **A 7 6**

Neumo biocontrol Gr.65 PN16/316L Ra < 0.8 µm **A 7 7**

Neumo biocontrol Gr.80 PN16/316L Ra < 0.8 µm **A 7 8**

SÜDMO DN50 PN10/316L/316L Ra < 0.8 µm **A 8 0**

Small flange DN25 PN1.5 DIN 28403/316L **A 8 1**

pol.Ra < 0.8 µm

Small flange DN40 PN1.5 DIN 28403/316L **A 8 2**

pol.Ra < 0.8 µm

Ingold connection PN16/316L Ra < 0.8 µm **A 8 3**

Terminal DN33.7 PN40 DIN 11864-3-A-/316L BN2 **A 8 4**

Ra < 0.8 µm

Hygienic fl. DN50 PN16 DIN 11864-2-A-/316L **A 8 5**

Ra < 0.8 µm

Flange DN25 PN6 Form C, DIN 2501/316L **A 8 6**

Flange DN25 PN6 Form C, DIN 2501/PFA<sup>5)</sup> **A 8 7**

Flange DN25 PN40 Form C, DIN 2501/316L **A 8 8**

Flange DN25 PN40 Form C, DIN 2501/Hastelloy **B 0 0**

Flange DN25 PN40 Form C, DIN 2501/ECTFE<sup>5)</sup> **B 0 1**

Flange DN25 PN40 Form C, DIN 2501/PFA<sup>5)</sup> **B 0 2**

Flange DN25 PN40 Form D, DIN 2501/316L **B 0 3**

Selection and Ordering data	Order No.
<b>SITRANS LVL200, Rigid extension</b> Compact vibrating level switch for use in liquid applications such as overflow, high, low and demand applications, as well as pump protection. For use in SIL-2 and hazardous applications.	<b>7 M L 5 7 4 7 -</b>
Flange DN25 PN40 Form F, DIN 2501/316L	<b>B 0 4</b>
Flange DN25 PN40 Form N, DIN 2501/316L	<b>B 0 5</b>
Flange DN25 PN40 Form N, DIN 2501/Hastelloy	<b>B 0 6</b>
Flange DN25 PN40 Form N, DIN 2501/Monel solid	<b>B 0 7</b>
Flange DN25 PN40 V13, DIN 2501/316L	<b>B 0 8</b>
Flange DN32 PN40 Form C, DIN 2501/316L	<b>B 1 0</b>
Flange DN32 PN40 Form C, DIN 2501/ECTFE <sup>5)</sup>	<b>B 1 1</b>
Flange DN40 PN6 Form C, DIN 2501/316L	<b>B 1 2</b>
Flange DN40 PN6 Form C, DIN 2501/ECTFE <sup>5)</sup>	<b>B 1 3</b>
Flange DN40 PN40 Form C, DIN 2501/316L	<b>B 1 4</b>
Flange DN40 PN40 Form C, DIN 2501/Hastelloy	<b>B 1 5</b>
Flange DN40 PN40 Form C, DIN 2501/ECTFE <sup>5)</sup>	<b>B 1 6</b>
Flange DN40 PN40 Form C, DIN 2501/PFA <sup>5)</sup>	<b>B 1 7</b>
Flange DN40 PN40 Form C, DIN 2501/Enamelled <sup>6)</sup>	<b>B 1 8</b>
Flange DN40 PN40 Form F, DIN 2501/316L	<b>B 2 0</b>
Flange DN40 PN40 Form N, DIN 2501/316L	<b>B 2 1</b>
Flange DN40 PN40 Form E, DIN 2501/316L	<b>B 2 2</b>
Flange DN40 PN40 V13, DIN 2501/316L	<b>B 2 3</b>
Flange DN50 PN40 Form C, DIN 2501/316L	<b>B 2 4</b>
Flange DN50 PN40 Form C, DIN 2501/Hastelloy	<b>B 2 5</b>
Flange DN50 PN40 Form C, DIN 2501/ECTFE <sup>5)</sup>	<b>B 2 6</b>
Flange DN50 PN40 Form C, DIN 2501/ECTFE (ZB3108) <sup>5)</sup>	<b>B 2 7</b>
Flange DN50 PN40 Form C, DIN 2501/PFA <sup>5)</sup>	<b>B 2 8</b>
Flange DN50 PN40 Form D, DIN 2501/316L	<b>B 3 0</b>
Flange DN50 PN40 Form D, DIN 2501/Hastelloy	<b>B 3 1</b>
Flange DN50 PN40 Form F, DIN 2501/316L	<b>B 3 2</b>
Flange DN50 PN40 Form N, DIN 2501/316L	<b>B 3 3</b>
Flange DN50 PN40 Form N, DIN 2501/Hastelloy	<b>B 3 4</b>
Flange DN50 PN40 Form E, DIN 2501/316L	<b>B 3 5</b>
Flange DN50 PN40 V13, DIN 2501/316L	<b>B 3 6</b>
Flange DN50 PN40 R13, DIN 2501/316L	<b>B 3 7</b>
Flange DN50 PN64 Form F, DIN 2501/316L	<b>B 3 8</b>
Flange DN50 PN64 Form N, DIN 2501/Hastelloy	<b>B 4 0</b>
Flange DN50 PN64 Form C, DIN 2501/316L	<b>B 4 1</b>
Flange DN50 PN64 Form L, DIN 2501/316L	<b>B 4 2</b>
Flange DN50 PN100 Form E, DIN 2501/316L	<b>B 4 3</b>
Flange DN50 PN100 Form L, DIN 2501/316L	<b>B 4 4</b>
Flange DN65 PN40 Form C, DIN 2501/316L	<b>B 4 5</b>
Flange DN65 PN40 Form C, DIN 2501/Hastelloy	<b>B 4 6</b>
Flange DN65 PN40 Form C, DIN 2501/ECTFE <sup>5)</sup>	<b>B 4 7</b>
Flange DN65 PN40 Form C, DIN 2501/PFA <sup>5)</sup>	<b>B 4 8</b>
Flange DN65 PN40 Form F, DIN 2501/316L	<b>B 5 0</b>
Flange DN65 PN64 Form E, DIN 2501/316L	<b>B 5 1</b>
Flange DN80 PN40 Form C, DIN 2501/316L	<b>B 5 2</b>
Flange DN80 PN40 Form C, DIN 2501/Hastelloy	<b>B 5 3</b>
Flange DN80 PN40 Form C, DIN 2501/ECTFE <sup>5)</sup>	<b>B 5 4</b>
Flange DN80 PN40 Form C, DIN 2501/PFA <sup>5)</sup>	<b>B 5 5</b>
Flange DN80 PN40 Form F, DIN 2501/316L	<b>B 5 6</b>
Flange DN80 PN40 Form N, DIN 2501/316L	<b>B 5 7</b>
Flange DN80 PN40 Form N, DIN 2501/Hastelloy	<b>B 5 8</b>
Flange DN100 PN16 Form C, DIN 2501/316L	<b>B 6 0</b>
Flange DN100 PN16 Form C, DIN 2501/Hastelloy	<b>B 6 1</b>
Flange DN100 PN16 Form C, DIN 2501/ECTFE <sup>5)</sup>	<b>B 6 2</b>
Flange DN100 PN16 Form C, DIN 2501/PFA <sup>5)</sup>	<b>B 6 3</b>
Flange DN100 PN16 Form D, DIN 2501/316L	<b>B 6 4</b>
Flange DN100 PN16 Form F, DIN 2501/316L	<b>B 6 5</b>
Flange DN100 PN16 Form N, DIN 2501/316L	<b>B 6 6</b>

Selection and Ordering data	Order No.
<b>SITRANS LVL200, Rigid extension</b> Compact vibrating level switch for use in liquid applications such as overflow, high, low and demand applications, as well as pump protection. For use in SIL-2 and hazardous applications.	<b>7 M L 5 7 4 7 -</b>
Flange DN100 PN40 Form C, DIN 2501/316L	<b>B 6 7</b>
Flange DN100 PN40 Form C, DIN 2501/ECTFE <sup>5)</sup>	<b>B 6 8</b>
Flange DN100 PN40 Form C, DIN 2501/PFA <sup>5)</sup>	<b>B 7 0</b>
Flange DN100 PN40 Form C, DIN 2501/Enamelled <sup>6)</sup>	<b>B 7 1</b>
Flange DN100 PN40 Form F, DIN 2501/316L	<b>B 7 2</b>
Flange DN100 PN40 Form N, DIN 2501/316L	<b>B 7 3</b>
Flange DN100 PN40 V13, DIN 2501/316L	<b>B 7 4</b>
Flange DN100 PN64 Form E, DIN 2501/316L	<b>B 7 5</b>
Flange DN100 PN100 Form E, DIN 2501/316L	<b>B 7 6</b>
Flange DN100 PN100 Form L, DIN 2501/316L	<b>B 7 7</b>
Flange DN125 PN16 Form F, DIN 2501/316L	<b>B 7 8</b>
Flange DN125 PN40 Form C, DIN 2501/316L	<b>B 8 0</b>
Flange DN125 PN40 Form N, DIN 2512/316L	<b>B 8 1</b>
Flange DN150 PN16 Form C, DIN 2501/316L	<b>B 8 2</b>
Flange DN150 PN16 Form C, DIN 2501/Hastelloy	<b>B 8 3</b>
Flange DN150 PN16 Form C, DIN 2501/ECTFE <sup>5)</sup>	<b>B 8 4</b>
Flange DN150 PN16 Form C, DIN 2501/PFA <sup>5)</sup>	<b>B 8 5</b>
Flange DN150 PN16 Form D, DIN 2501/316L	<b>B 8 6</b>
Flange DN150 PN40 Form C, DIN 2501/316L	<b>B 8 7</b>
Flange DN150 PN40 Form C, DIN 2501/Hastelloy	<b>B 8 8</b>
Flange DN150 PN40 Form F, DIN 2501/316L	<b>C 0 0</b>
Flange DN150 PN40 Form N, DIN 2512/316L	<b>C 0 1</b>
Flange DN200 PN10 Form C, DIN 2501/ECTFE <sup>5)</sup>	<b>C 0 2</b>
Flange DN200 PN16 Form C, DIN 2501/316L	<b>C 0 3</b>
Flange DN25 PN40 Form B1, EN 1092-1/316L	<b>C 0 4</b>
Flange DN25 PN40 Form B1, EN 1092-1/Hastelloy	<b>C 0 5</b>
Flange DN25 PN40 Form B1, EN/316L/PFA <sup>5)</sup>	<b>C 0 6</b>
Flange DN25 PN40 Form B1, EN 1092-1/Enamelled <sup>6)</sup>	<b>C 0 7</b>
Flange DN25 PN40 Form B2, EN 1092-1/316L	<b>C 0 8</b>
Flange DN25 PN40 Form F, EN 1092-1/316L	<b>C 1 0</b>
Flange DN25 PN63 Form B1, EN 1092-1/316L	<b>C 1 1</b>
Flange DN25 PN100 Form B2, EN 1092-1/316L	<b>C 1 2</b>
Flange DN40 PN40 Form B1, EN/316L	<b>C 1 3</b>
Flange DN40 PN40 Form B1, EN 1092-1/PFA <sup>5)</sup>	<b>C 1 4</b>
Flange DN40 PN40 Form B2, EN/316L	<b>C 1 5</b>
Flange DN50 PN40 Form B1, EN/316L	<b>C 1 6</b>
Flange DN50 PN40 Form B1, EN 1092-1/Hastelloy	<b>C 1 7</b>
Flange DN50 PN40 Form B1, EN 1092-1/Monel ZB2977	<b>C 1 8</b>
Flange DN50 PN40 Form B1, EN 1092-1/ECTFE <sup>5)</sup>	<b>C 2 0</b>
Flange DN50 PN40 Form B1, EN/316L/PFA <sup>5)</sup>	<b>C 2 1</b>
Flange DN50 PN40 Form B1, EN 1092-1/Enamelled <sup>6)</sup>	<b>C 2 2</b>
Flange DN50 PN40 Form C, EN 1092-1/316L	<b>C 2 3</b>
Flange DN50 PN40 Form D, EN/316L	<b>C 2 4</b>
Flange DN50 PN40 Form D, EN 1092-1/Hastelloy	<b>C 2 5</b>
Flange DN50 PN40 Form B2, EN 1092-1/316L	<b>C 2 6</b>
Flange DN50 PN40 Form E, EN 1092-1/316L	<b>C 2 7</b>
Flange DN80 PN40 Form B1, EN 1092-1/316L	<b>C 2 8</b>
Flange DN80 PN40 Form B1, EN 1092-1/Hastelloy	<b>C 3 0</b>
Flange DN80 PN40 Form B1, EN 1092-1/ECTFE <sup>5)</sup>	<b>C 3 1</b>
Flange DN80 PN40 Form B1, EN 1092-1/Enamelled <sup>6)</sup>	<b>C 3 2</b>
Flange DN80 PN40 Form B2, EN 1092-1/316L	<b>C 3 3</b>
Flange DN100 PN16 Form B1, EN 1092-1/316L	<b>C 3 4</b>
Flange DN100 PN16 Form B1, EN 1092-1/Hastelloy	<b>C 3 5</b>
Flange DN100 PN16 Form B1, EN 1092-1/Enamelled <sup>6)</sup>	<b>C 3 6</b>



# Level Measurement

## SITRANS LVL200

### Selection and Ordering data

Order No.

#### SITRANS LVL200, Rigid extension

Compact vibrating level switch for use in liquid applications such as overflow, high, low and demand applications, as well as pump protection. For use in SIL-2 and hazardous applications.

7 M L 5 7 4 7 -

Flange DN100 PN40 Form B1, EN 1092-1/316L	C 37
Flange DN100 PN40 Form B1, EN 1092-1/Enamelled <sup>6)</sup>	C 38
Flange DN100 PN40 Form C, EN 1092-1/316L	C 40
Flange DN100 PN63 Form B2, EN 1092-1/316L	C 41
Flange DN150 PN16 Form B1, EN 1092-1/316L	C 42
Flange DN150 PN16 Form B1, EN 1092-1/PFA <sup>5)</sup>	C 43
Flange DN150 PN40 Form B1, EN 1092-1/316L	C 44
Flange DN150 PN40 Form B1, EN 1092-1/ECTFE <sup>5)</sup>	C 45
Flange DN150 PN40 Form B2, EN 1092-1/316L	C 46
Flange 1" 150lb ANSI B16.5/316L	C 47
Flange 1" 150lb RF, ANSI B16.5/Hastelloy	C 48
Flange 1" 150lb RF, ANSI B16.5/Monel ZB2977	C 50
Flange 1" 150lb RF, ANSI B16.5/ECTFE <sup>5)</sup>	C 51
Flange 1" 150lb RF, ANSI B16.5/PFA <sup>5)</sup>	C 52
Flange 1" 150lb RF, ANSI B16.5/Enamelled <sup>6)</sup>	C 53
Flange 1" 300lb RF, ANSI B16.5/316L	C 54
Flange 1" 300lb RF, ANSI B16.5/ECTFE <sup>5)</sup>	C 55
Flange 1" 600lb RF, ANSI B16.5/316L	C 56
Flange 1½" 150lb RF, ANSI B16.5/316L	C 57
Flange 1½" 150lb RF, ANSI B16.5/Hastelloy	C 58
Flange 1½" 150lb RF, ANSI B16.5/ECTFE <sup>5)</sup>	C 60
Flange 1½" 150lb RF, ANSI B16.5/PFA <sup>5)</sup>	C 61
Flange 1½" 150lb RF, ANSI B16.5 Enamelled <sup>6)</sup>	C 62
Flange 1½" 150lb FF, ANSI B16.5/ECTFE <sup>5)</sup>	C 63
Flange 1½" 300lb RF, ANSI B16.5/316L	C 64
Flange 1½" 300lb RF, ANSI B16.5/Monel ZB2977	C 65
Flange 1½" 300lb RF, ANSI B16.5/ECTFE <sup>5)</sup>	C 66
Flange 1½" 600lb RF, ANSI B16.5/316L	C 67
Flange 2" 150lb RF, ANSI B16.5/316L	C 68
Flange 2" 150lb RF, ANSI B16.5/Hastelloy	C 70
Flange 2" 150lb RF, ANSI B16.5/Monel ZB2977	C 71
Flange 2" 150lb RF, ANSI B16.5/ECTFE <sup>5)</sup>	C 72
Flange 2" 150lb RF, ANSI B16.5/PFA <sup>5)</sup>	C 73
Flange 2" 150lb RF, ANSI B16.5/Enamelled <sup>6)</sup>	C 74
Flange 2" 150lb FF, ANSI B16.5/316L	C 75
Flange 2" 150lb FF, ANSI B16.5/ECTFE <sup>5)</sup>	C 76
Flange 2" 150lb SG (small groove), ANSI B16.5/316L	C 77
Flange 2" 300lb RF, ANSI B16.5/316L	C 78
Flange 2" 300lb RF, ANSI B16.5/Hastelloy	C 80
Flange 2" 300lb RF, ANSI B16.5/Hastelloy	C 81
Flange 2" 300lb RF, ANSI B16.5/ECTFE <sup>5)</sup>	C 82
Flange 2" 300lb RF, ANSI B16.5/PFA <sup>5)</sup>	C 83
Flange 2" 300lb RF, ANSI B16.5 Enamelled <sup>6)</sup>	C 84
Flange 2" 300lb RJF, ANSI B16.5/316L	C 85
Flange 2" 300lb ST, ANSI B16.5/316L	C 86
Flange 2" 300lb LG (large groove), ANSI B16.5/316L	C 87
Flange 2" 300lb LT, ANSI B16.5/316L	C 88
Flange 2" 600lb RF, ANSI B16.5/316L	D 00
Flange 2" 600lb RF, ANSI B16.5/Monel ZB2977	D 01
Flange 2" 600lb RF, ANSI B16.5/ECTFE <sup>5)</sup>	D 02
Flange 2" 600lb RJF, ANSI B16.5/316L	D 03
Flange 2" 600lb LG, ANSI B16.5/316L	D 04
Flange 2" 900lb RJF, ANSI B16.5/316L	D 05
Flange 2½" 150lb RF, ANSI B16.5/316L	D 06
Flange 2½" 300lb RF, ANSI B16.5/316L	D 07
Flange 3" 150lb RF, ANSI B16.5/316L	D 08
Flange 3" 150lb RF, ANSI B16.5/Hastelloy	D 10

### Selection and Ordering data

Order No.

#### SITRANS LVL200, Rigid extension

Compact vibrating level switch for use in liquid applications such as overflow, high, low and demand applications, as well as pump protection. For use in SIL-2 and hazardous applications.

7 M L 5 7 4 7 -

Flange 3" 150lb RF, ANSI B16.5/Monel ZB2977	D 11
Flange 3" 150lb RF, ANSI B16.5/ECTFE <sup>5)</sup>	D 12
Flange 3" 150lb RF, ANSI B16.5/PFA <sup>5)</sup>	D 13
Flange 3" 150lb RF, ANSI B16.5/Enamelled <sup>6)</sup>	D 14
Flange 3" 150lb FF, ANSI B16.5/316L	D 15
Flange 3" 150lb FF, ANSI B16.5/ECTFE <sup>5)</sup>	D 16
Flange 3" 150lb FF, ANSI B16.5/PFA <sup>5)</sup>	D 17
Flange 3" 300lb RF, ANSI B16.5/316L	D 18
Flange 3" 300lb RF, ANSI B16.5/Hastelloy	D 20
Flange 3" 300lb RF, ANSI B16.5/ECTFE <sup>5)</sup>	D 21
Flange 3" 300lb RF, ANSI B16.5/PFA <sup>5)</sup>	D 22
Flange 3" 300lb RF, ANSI B16.5/Enamelled <sup>6)</sup>	D 23
Flange 3" 600lb RF, ANSI B16.5/316L	D 24
Flange 3½" 150lb RF, ANSI B16.5/316L	D 25
Flange 3½" 150lb RF, ANSI B16.5/ECTFE <sup>5)</sup>	D 26
Flange 4" 150lb RF, ANSI B16.5/316L	D 27
Flange 4" 150lb RF, ANSI B16.5/Hastelloy	D 28
Flange 4" 150lb RF, ANSI B16.5/ECTFE <sup>5)</sup>	D 30
Flange 4" 150lb RF, ANSI B16.5/PFA <sup>5)</sup>	D 31
Flange 4" 150lb RF, ANSI B16.5/Enamelled <sup>6)</sup>	D 32
Flange 4" 150lb LT, ANSI B16.5/316L	D 33
Flange 4" 300lb RF, ANSI B16.5/316L	D 34
Flange 4" 300lb RF, ANSI B16.5/Hastelloy	D 35
Flange 4" 300lb RF, ANSI B16.5/ECTFE <sup>5)</sup>	D 36
Flange 4" 300lb RJF, ANSI B16.5/316L	D 37
Flange 4" 300lb LG, ANSI B16.5/316L	D 38
Flange 4" 300lb LT, ANSI B16.5/316L	D 40
Flange 4" 600lb RF, ANSI B16.5/316L	D 41
Flange 4" 600lb RJF, ANSI B16.5/316L	D 42
Flange 5" 150lb RF, ANSI B16.5/316L	D 43
Flange 6" 150lb RF, ANSI B16.5/316L	D 44
Flange 6" 150lb RF, ANSI B16.5/Hastelloy	D 45
Flange 6" 150lb RF, ANSI B16.5/ECTFE <sup>5)</sup>	D 46
Flange 6" 150lb RF, ANSI B16.5/PFA <sup>5)</sup>	D 47
Flange 6" 150lb RJF, ANSI B16.5/316L	D 48
Flange 6" 300lb RF, ANSI B16.5/316L	D 50
Flange 8" 150lb RF, ANSI B16.5/316L	D 51
Flange 8" 150lb RF, ANSI B16.5/ECTFE <sup>5)</sup>	D 52
Flange 1" BS.10 Table E/316L	D 53
Flange 1" BS.10 Table E/PFA <sup>5)</sup>	D 54
Flange 1½" BS.10 Table E/316L	D 55
Flange 3½" BS.10 Table E/316L	D 56
Flange 4" BS.10 Table E/ECTFE <sup>5)</sup>	D 57
Flange DN40 10K, JIS/316L	D 58
Flange DN50 10K, JIS/316L	D 60
Flange DN80 10K, JIS/316L	D 61
Flange DN100 10K, JIS/316L	D 62

Selection and Ordering data	Order No.
<b>SITRANS LVL200, Rigid extension</b> Compact vibrating level switch for use in liquid applications such as overflow, high, low and demand applications, as well as pump protection. For use in SIL-2 and hazardous applications.	7 ML 5 7 4 7 -
<b>Adapter/Process temperature</b>	
Without adapter/-50 ... 150 °C	1
With adapter/-50 ... 200 °C <sup>7)</sup>	2
With adapter/-50... 250 °C	3
With gas-tight leadthrough/-50 ... +150 °C	4
With gas-tight leadthrough/-50 ... +250 °C	5
<b>Housing/ Cable entry</b>	
Aluminium IP66/IP67/M20x1.5	A
Aluminium IP66/IP67/½" NPT	B
<b>NOTE:</b>	
<b>When selecting a Rigid Extension option, extension coating must match the process connection coating and the material and surface roughness type.</b>	
<b>Rigid Extension 316L</b>	
80 ... 500 mm	A 0
501 ... 1000 mm	A 1
1001 ... 1500 mm	A 2
1501 ... 2000 mm	A 3
2001 ... 2500 mm	A 4
2501 ... 3000 mm	A 5
3001 ... 3500 mm	A 6
3501 ... 4000 mm	A 7
<b>Rigid Extension ECTFE coated<sup>5)</sup></b>	
80 ... 500 mm	B 0
501 ... 1000 mm	B 1
1001 ... 1500 mm	B 2
1501 ... 2000 mm	B 3
2001 ... 2500 mm	B 4
2501 ... 3000 mm	B 5
3001 ... 3500 mm	B 6
3501 ... 4000 mm	B 7
<b>Rigid Extension PFA coated<sup>5)</sup></b>	
80 ... 500 mm	C 0
501 ... 1000 mm	C 1
1001 ... 1500 mm	C 2
1501 ... 2000 mm	C 3
2001 ... 2500 mm	C 4
2501 ... 3000 mm	C 5
<b>Rigid Extension 316L Ra ≤ 0.8 µm</b>	
80 ... 500 mm	D 0
501 ... 1000 mm	D 1
1001 ... 1500 mm	D 2
1501 ... 2000 mm	D 3
2001 ... 2500 mm	D 4
2501 ... 3000 mm	D 5
3001 ... 3500 mm	D 6
3501 ... 4000 mm	D 7
<b>Rigid Extension 316L Ra ≤ 0.3 µm</b>	
80 ... 500 mm	E 0
501 ... 1000 mm	E 1
1001 ... 1500 mm	E 2
1501 ... 2000 mm	E 3
2001 ... 2500 mm	E 4
2501 ... 3000 mm	E 5
3001 ... 3500 mm	E 6
3501 ... 4000 mm	E 7

Selection and Ordering data	Order No.
<b>SITRANS LVL200, Rigid extension</b> Compact vibrating level switch for use in liquid applications such as overflow, high, low and demand applications, as well as pump protection. For use in SIL-2 and hazardous applications.	7 ML 5 7 4 7 -
<b>Rigid Extension Enamelled version<sup>6)</sup></b>	
80 ... 250 mm	F 0
251 ... 500 mm	F 1
501 ... 750 mm	F 2
751 ... 1000 mm	F 3
1001 ... 1250 mm	F 4
1251 ... 1500 mm	F 5
<b>Rigid Extension Hastelloy</b>	
80 ... 500 mm	G 0
501 ... 1000 mm	G 1
1001 ... 1500 mm	G 2
1501 ... 2000 mm	G 3
2001 ... 2500 mm	G 4
2501 ... 3000 mm	G 5
3001 ... 3500 mm	G 6
3501 ... 4000 mm	G 7
<b>Rigid Extension Monel</b>	
80 ... 500 mm	H 0
501 ... 1000 mm	H 1
1001 ... 1500 mm	H 2
1501 ... 2000 mm	H 3
2001 ... 2500 mm	H 4
2501 ... 3000 mm	H 5

- 1) Available with Approval options A to G, and K, and Adapter/Process temperature options 1, and 3 to 5 only
- 2) Available with Electronics option 4 only
- 3) Available with Adapter/Process temperature options 1 and 3 only
- 4) Available with Housing/Cable entry option B only
- 5) Available with Adapter/Process temperature options 1 and 4 only
- 6) Available with Adapter/Process temperature options 1, 2, and 4 only
- 7) Available with enamelled Process connection and Extension options only

# Level Measurement

## SITRANS LVL200

### Selection and Ordering data

### Order code

#### Further designs

Please add **"-Z"** to Order No. and specify Order code(s).

Cleaning including Certificate (oil, grease and silicone free)

**W01**

Enter the total insertion length in plain text description, max. 4000 mm (157.48")

**Y01**

Identification Label (measurement loop) SS: max. 16 characters add in plain text

**Y17**

Identification Label (measurement loop) Foil: max. 16 characters add in plain text

**Y18**

Acceptance test certificate 3.1 NACE MR 0775 for material EN10204

**D07**

Acceptance test certificate 3.1 for instrument

**C12**

Acceptance test certificate 2.2 for instrument

**C14**

Acceptance test Certificate 2.2 for material EN10204

**C15**

SIL/IEC61508 Certificate of conformity (SIL-2/3 min. and max. detection)

**C20**

#### Additional Operating Instructions

#### Order No.

##### LVL200 Extended (DPDT Relay)

• English

**7ML1998-5KW01**

• French

**7ML1998-5KW11**

• Spanish

**7ML1998-5KW21**

• German

**7ML1998-5KW31**

##### LVL200 (Contactless electronic switch)

• English

**7ML1998-5KV01**

• French

**7ML1998-5KV11**

• Spanish

**7ML1998-5KV21**

• German

**7ML1998-5KV31**

##### Electronics module LVL200 Relay

• English

**7ML1998-5LS01**

• French

**7ML1998-5LS11**

• Spanish

**7ML1998-5LS21**

• German

**7ML1998-5LS31**

This device is shipped with the Siemens Milltronics manual CD containing the complete Operating Instructions library.

#### Spare Parts

Electronics module SITRANS LVL200 Relay

**7ML1830-1NC**

Lock fitting, unpressurized, G1A/316L

**7ML1930-1DQ**

Lock fitting, unpressurized, 1NPT/316L

**7ML1930-1DR**

Lock fitting, unpressurized, 1-1/2NPT/316L

**7ML1930-1DS**

Lock fitting, unpressurized, G1-1/2A/316L

**7ML1930-1DT**

Lock fitting, unpressurized, 1-1/2NPT/316L

**7ML1930-1DU**

Lock fitting, -1... 16 bar, G1A/316L

**7ML1930-1DV**

Lock fitting, -1... 16 bar, 1NPT/316L

**7ML1930-1DW**

Lock fitting, -1... 16 bar, G1-1/2A/316L

**7ML1930-1DX**

Lock fitting, -1... 16 bar, 1-1/2NPT/316L

**7ML1930-1EA**

Lock fitting, -1... 64 bar, G1A/316L

**7ML1930-1EB**

Lock fitting, -1... 64 bar, 1NPT/316L

**7ML1930-1EC**

Lock fitting, -1... 64 bar, G1-1/2A/316L

**7ML1930-1ED**

## Options

## LVL200 Threaded Welded Socket

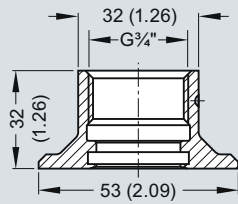
G $\frac{3}{4}$ " A/316L

G1" A/316L

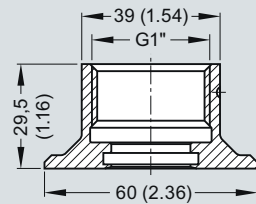

## Lock fitting

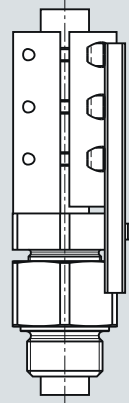
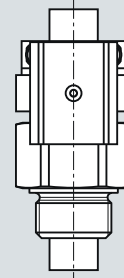
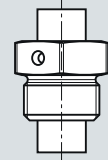
LVL200 Extended  
64 barLVL200 Extended  
16 barLVL200 Extended  
Unpressurized

SITRANS LVL200 welded socket and lock fitting, dimensions in mm (inch)

# Level Measurement

## SITRANS LVL200

### Characteristic curves

Ambient/Process temperature

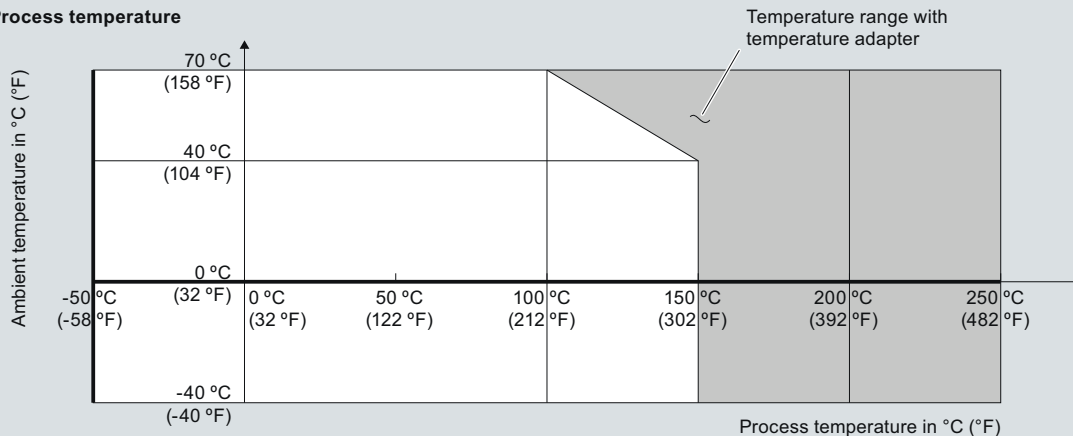

Process pressure with switch position 0.7 g/cm³ (mode switch)

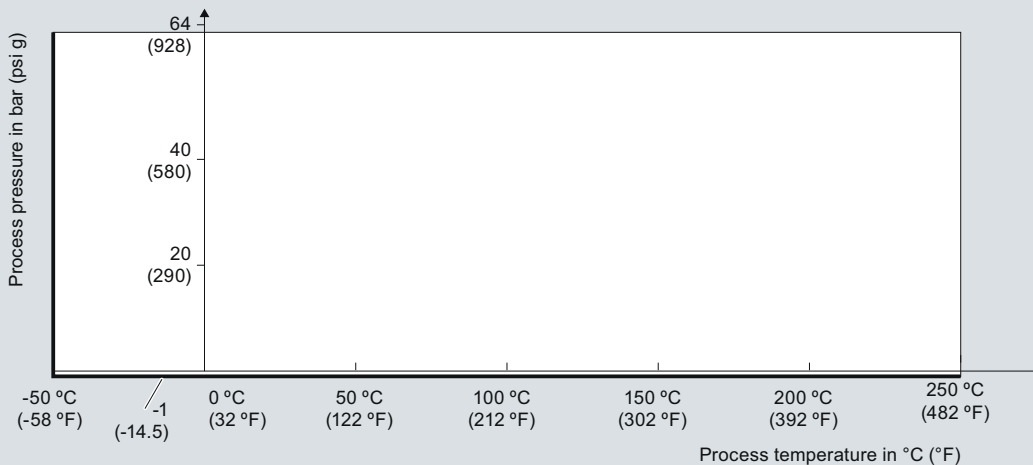

Process pressure with switch position 0.5 g/cm³ (mode switch)

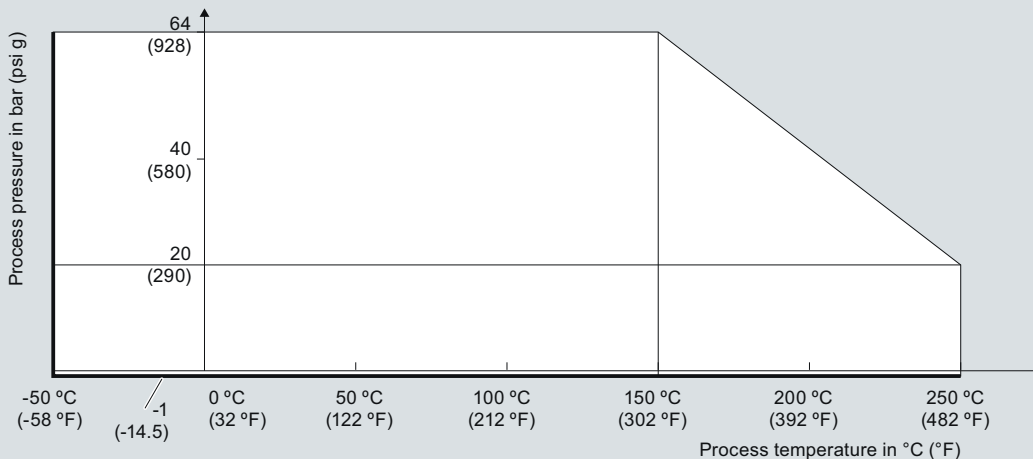

SITRANS LVL200 Process Pressure/Process Temperature/Ambient Temperature derating curves

5

### Dimensional drawings

#### SITRANS LVL200 (Standard)

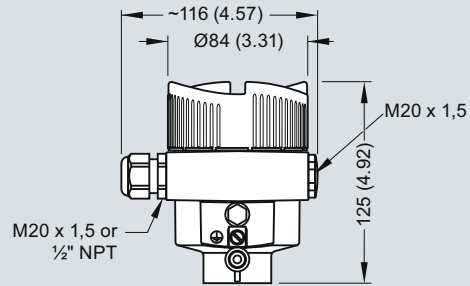

#### Threaded

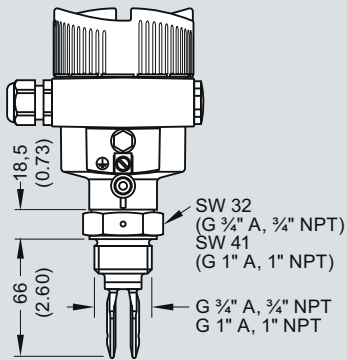

#### Tri-Clamp

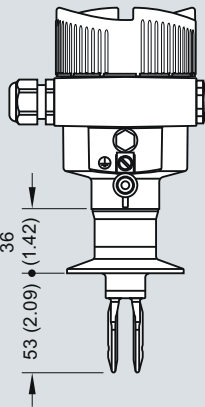

#### Cone DN25

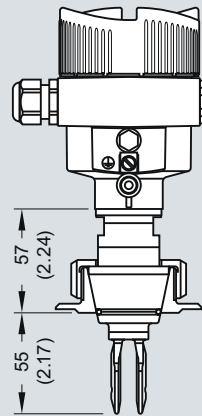

#### Temperature adapter

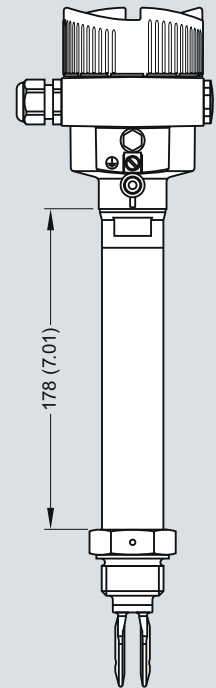

#### Bolting DN40

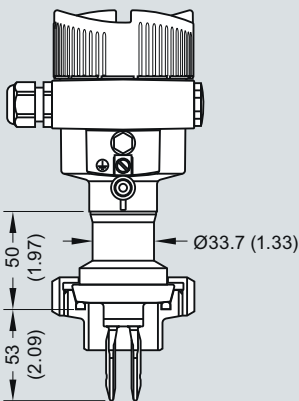

#### Flange

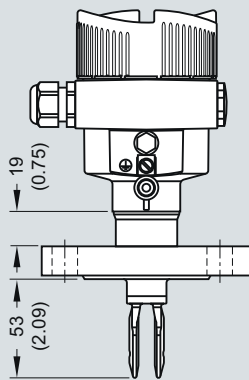

#### Gas-tight leadthrough

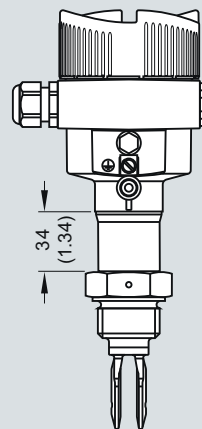

SITRANS LVL200 (Standard), dimensions in mm (inch)

# Level Measurement

## SITRANS LVL200

SITRANS LVL200 (Extended)

Sensor length (L)

316L, Hastelloy C4 (2.4610)	80 ... 6000 mm (3.15 ... 236.2")
Hastelloy C4 (2.4610) enamelled	80 ... 1500 mm (3.15 ... 59.06")
316L, ECTFE coated	80 ... 3000 mm (3.15 ... 118.1")
316L, PFA coated	80 ... 3000 mm (3.15 ... 118.1")

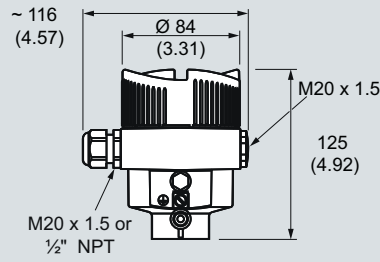

Threaded

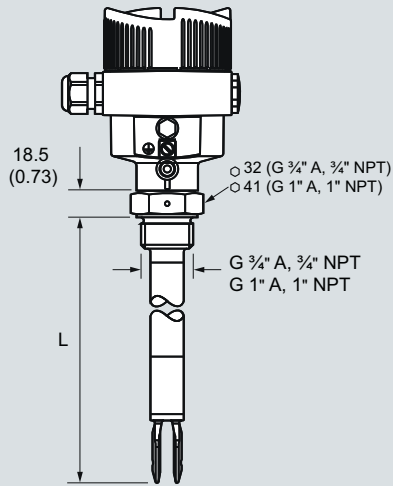

Tri-clamp

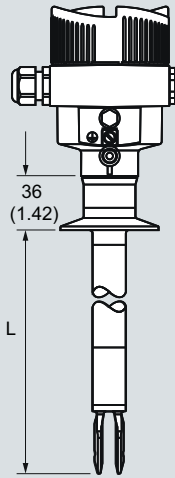

Cone DN25

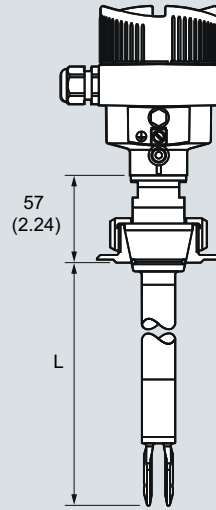

Bolting DN40

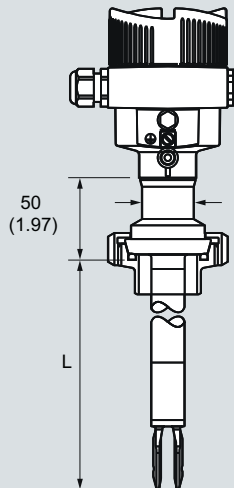

Flanged

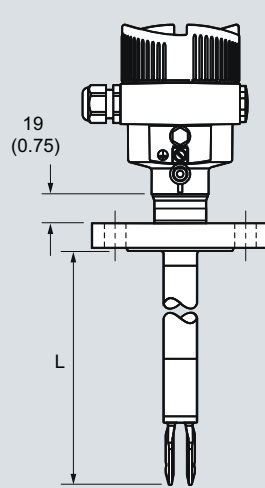

Gas-tight leadthrough

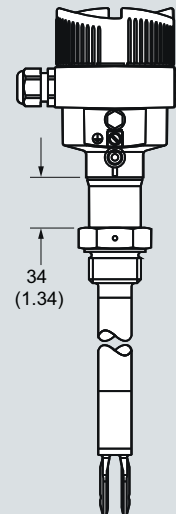

Temperature adapter

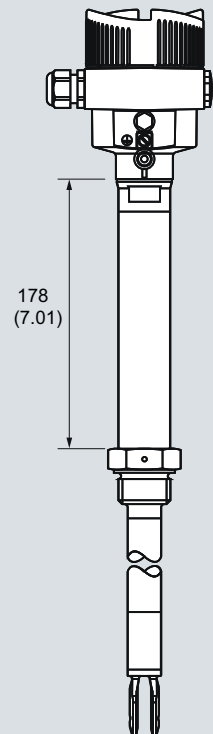

SITRANS LVL200 (Extended), dimensions in mm (inch)

5

## SITRANS LVL200

### Schematics

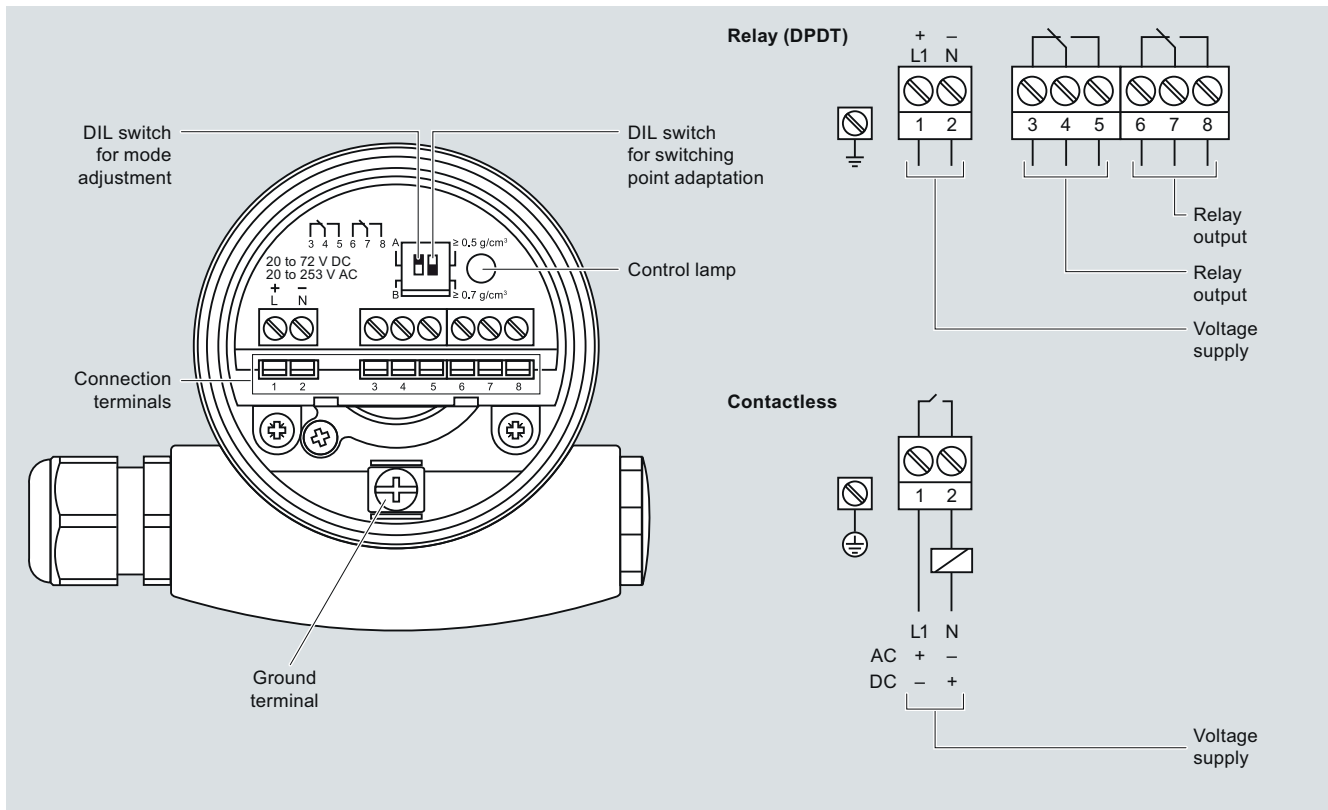

SITRANS LVL200 connections