

SIEMENS

SITRANS F

Coriolis Flowmeters SITRANS FC310

Compact Operating Instructions

<u>Introduction</u>	1
<u>Safety notes</u>	2
<u>Installing/mounting</u>	3
<u>Connecting</u>	4
<u>Commissioning</u>	5
<u>Service and maintenance</u>	6
<u>Technical data</u>	7
<u>Certificates and support</u>	A

7ME4631 (SITRANS FC310)

Legal information

Warning notice system

This manual contains notices you have to observe in order to ensure your personal safety, as well as to prevent damage to property. The notices referring to your personal safety are highlighted in the manual by a safety alert symbol, notices referring only to property damage have no safety alert symbol. These notices shown below are graded according to the degree of danger.

⚠ DANGER
indicates that death or severe personal injury will result if proper precautions are not taken.

⚠ WARNING
indicates that death or severe personal injury may result if proper precautions are not taken.

⚠ CAUTION
indicates that minor personal injury can result if proper precautions are not taken.

NOTICE
indicates that property damage can result if proper precautions are not taken.

If more than one degree of danger is present, the warning notice representing the highest degree of danger will be used. A notice warning of injury to persons with a safety alert symbol may also include a warning relating to property damage.

Qualified Personnel

The product/system described in this documentation may be operated only by **personnel qualified** for the specific task in accordance with the relevant documentation, in particular its warning notices and safety instructions. Qualified personnel are those who, based on their training and experience, are capable of identifying risks and avoiding potential hazards when working with these products/systems.

Proper use of Siemens products

Note the following:

⚠ WARNING
Siemens products may only be used for the applications described in the catalog and in the relevant technical documentation. If products and components from other manufacturers are used, these must be recommended or approved by Siemens. Proper transport, storage, installation, assembly, commissioning, operation and maintenance are required to ensure that the products operate safely and without any problems. The permissible ambient conditions must be complied with. The information in the relevant documentation must be observed.

Trademarks

All names identified by ® are registered trademarks of Siemens AG. The remaining trademarks in this publication may be trademarks whose use by third parties for their own purposes could violate the rights of the owner.

Disclaimer of Liability

We have reviewed the contents of this publication to ensure consistency with the hardware and software described. Since variance cannot be precluded entirely, we cannot guarantee full consistency. However, the information in this publication is reviewed regularly and any necessary corrections are included in subsequent editions.

Table of contents

1	Introduction	5
1.1	Purpose of this documentation.....	5
1.2	Document history	5
1.3	Device identification	5
1.4	Designated use	9
1.5	Product compatibility	10
1.6	Checking the consignment.....	10
1.7	Security information	10
1.8	Transportation and storage.....	11
1.9	Notes on warranty	11
2	Safety notes	13
2.1	Preconditions for use	13
2.1.1	Warning symbols on the device	13
2.1.2	Conformity with European directives.....	14
2.2	Requirements for special applications	15
2.3	Use in hazardous areas	15
3	Installing/mounting	19
3.1	Basic safety notes	19
3.1.1	Installation location requirements.....	20
3.1.2	Proper mounting.....	21
3.2	Installation instructions	22
3.2.1	Orientation of the sensor	23
3.3	Disassembly	26
4	Connecting	27
4.1	Basic safety notes	27
4.2	Connecting the FC310	31
4.2.1	Warnings	31
5	Commissioning	35
5.1	Basic safety notes	35
6	Service and maintenance	39
6.1	Basic safety notes	39
6.2	Cleaning	40
6.3	Maintenance and repair work.....	41

6.3.1	Ex-approved products	43
6.4	Replacing the device	44
6.5	Return procedure	44
6.6	Disposal	45
7	Technical data	47
7.1	Modbus Communication Specification	47
7.2	Operating conditions	48
7.3	Certificates and approvals	49
A	Certificates and support.....	51
A.1	Technical support.....	51
A.2	Certificates	51
	Index.....	53

Introduction

1.1 Purpose of this documentation

These instructions contain all information required to commission and use the device. Read the instructions carefully prior to installation and commissioning. In order to use the device correctly, first review its principle of operation.

The instructions are aimed at persons mechanically installing the device, connecting it electronically, configuring the parameters and commissioning it, as well as service and maintenance engineers.

See also

Certificates (Page 51)

Technical support (Page 51)

1.2 Document history

The following table shows major changes in the documentation compared to the previous edition.

The most important changes in the documentation when compared with the respective previous edition are given in the following table.

Edition	Note
01/2019	Second edition <ul style="list-style-type: none"> • Chapter Technical data (Page 47) updated • Overall revision of chapters and contents
06/2018	First edition

1.3 Device identification

The FC310 Coriolis flowmeter has 3 nameplate types which show the following information:

- product identification
- product specifications
- certificates and approvals

Note Identification

Identify your device by comparing your ordering data with the information on the product and specification nameplates.

FC310 identification nameplate example

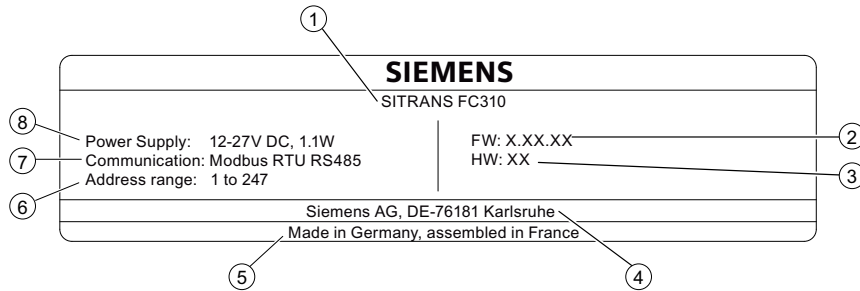

- | | | |
|---|---------------|--------------------------------------|
| ① | SITRANS FC310 | Product name |
| ② | FW | System revision number firmware (FW) |
| ③ | HW | System revision number hardware (HW) |
| ④ | Manufacturer | Manufacturer name and location |
| ⑤ | Country | Manufacturing country |
| ⑥ | Address range | Address range |
| ⑦ | Communication | Communication |
| ⑧ | Power Supply | Power supply |

FCS300 identification nameplate example

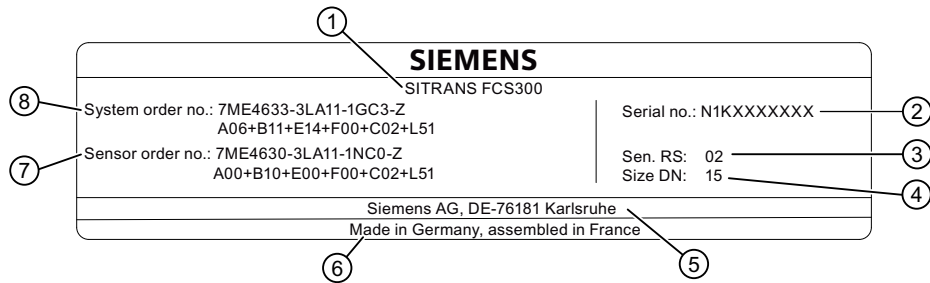

- | | | |
|---|-------------------|--|
| ① | SITRANS
FCS300 | Product name |
| ② | Serial no. | Serial number |
| ③ | Sen. RS | Mechanical sensor version number |
| ④ | Size DN | Size |
| ⑤ | Manufacturer | Manufacturer name and location |
| ⑥ | Country | Manufacturing country |
| ⑦ | Sensor order no. | Sensor replacement order number |
| ⑧ | System order no. | Flowmeter system order number (transmitter and sensor) |

Flowmeter serial number construction

The flowmeter serial number consists of the following:

PPYMDDXXXX

where

PP = Production factory (Siemens Flow Instruments: N1)

Y = Production year (for encryption, see below)

M = Production month (for encryption, see below)

DD = Production day (for encryption, see below)

XXXX = Sequential number

Encryption:

Calendar year (Y)	Code
1950, 1970, 1990, 2010	A
1951, 1971, 1991, 2011	B
1952, 1972, 1992, 2012	C
1953, 1973, 1993, 2013	D
1954, 1974, 1994, 2014	E
1955, 1975, 1995, 2015	F
1956, 1976, 1996, 2016	H (G)
1957, 1977, 1997, 2017	J
1958, 1978, 1998, 2018	K
1959, 1979, 1999, 2019	L
1960, 1980, 2000, 2020	M
1961, 1981, 2001, 2021	N
1962, 1982, 2002, 2022	P
1963, 1983, 2003, 2023	R
1964, 1984, 2004, 2024	S
1965, 1985, 2005, 2025	T
1966, 1986, 2006, 2026	U
1967, 1987, 2007, 2027	V
1968, 1988, 2008, 2028	W
1969, 1989, 2009, 2029	X
Month (M)	Code
January	1
February	2
March	3
April	4
May	5
June	6
July	7
August	8
September	9
October	O
November	N
December	D

1.3 Device identification

Day (DD)

Day 01 to 31

Code

01 to 31 (corresponding to the actual date)

FC310 specification nameplate example

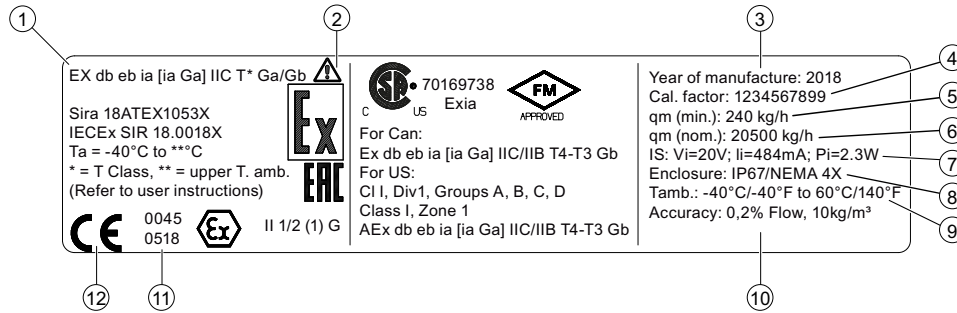

- | | | |
|---|---------------------|---|
| ① | Ex approvals | Classification for hazardous locations |
| ② | ⚠ | Consult the operating instructions |
| ③ | Year of manufacture | Manufacturing year
More detailed date of manufacture information is given in the serial number on the identification nameplate |
| ④ | Cal. factor | Calibration factor |
| ⑤ | qm (min) | Minimum mass flows with water at 20 °C (68 °F) |
| ⑥ | qm (nom) | Nominal mass flows with water at 20 °C (68 °F) |
| ⑦ | IS | Intrinsic Safety + Parameter |
| ⑧ | Enclosure | Degree of protection |
| ⑨ | Tamb. | Range of ambient temperature |
| ⑩ | Accuracy | Mass flow, density calibration accuracy |
| ⑪ | 0518 | Notified Body ID (ATEX example) |
| ⑫ | CE | CE mark |

Note

Approvals and identifications

Approval certificates and notified body identifications are available for download at www.siemens.com (www.siemens.com).

FC310 approval nameplate example

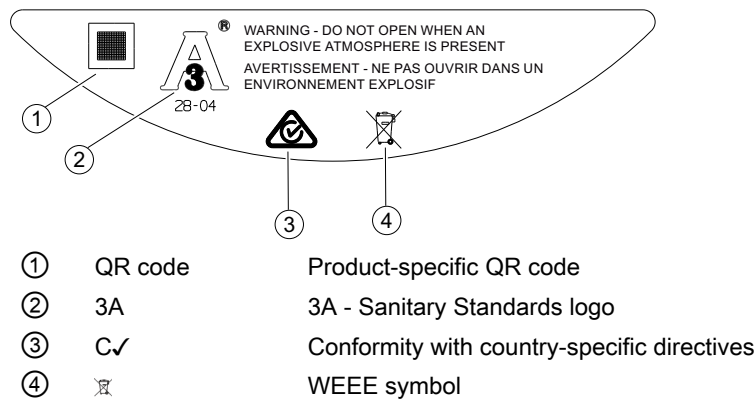

Note

Logos and warnings

Logos and warnings are only shown on the product where applicable. The combination shown in the example above is relevant for a hygienic sensor installed in hazardous area in Canada.

The Australian C-tick mark is mandatory on all products.

QR code

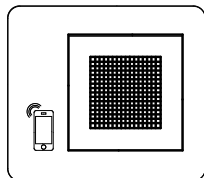

With the use of a smart phone, the QR code provides a direct link to

- the product support portal
- the product and production-specific documentation maintained in the production database.

1.4 Designated use

You can use the Coriolis flowmeter for the following measuring tasks:

- Mass flow
- Volume flow
- Density
- Process temperature

Operate the device according to the specifications in section Technical data (Page 47).

For additional information, refer to the operating instructions for the device.

1.5 Product compatibility

Manual edition	Remarks	Device revision	Compatibility of device integration package	
01/2019	Manual content updated	Modbus RS-485 RTU FW: 4.00.00-xx HW: 3	SIMATIC PDM V8.2 Service Pack 1	EDD: 2.00.xx or later
06/2018	New hardware New sensor sizes	Modbus RS-485 RTU FW: 4.00.00-xx HW: 3	SIMATIC PDM V8.2 Service Pack 1	EDD: 2.00.xx or later

NOTICE
Use in a domestic environment
This Class A Group 1 equipment is intended for use in industrial areas. In a domestic environment this device may cause radio interference.

1.6 Checking the consignment

1. Check the packaging and the delivered items for visible damages.
2. Report any claims for damages immediately to the shipping company.
3. Retain damaged parts for clarification.
4. Check the scope of delivery by comparing your order to the shipping documents for correctness and completeness.

 WARNING
Using a damaged or incomplete device
Risk of explosion in hazardous areas.
<ul style="list-style-type: none"> • Do not use damaged or incomplete devices.

1.7 Security information

Siemens provides products and solutions with industrial security functions that support the secure operation of plants, systems, machines and networks.

In order to protect plants, systems, machines and networks against cyber threats, it is necessary to implement – and continuously maintain – a holistic, state-of-the-art industrial security concept. Siemens' products and solutions constitute one element of such a concept.

Customers are responsible for preventing unauthorized access to their plants, systems, machines and networks. Such systems, machines and components should only be connected to an enterprise network or the internet if and to the extent such a connection is necessary and

only when appropriate security measures (e.g. firewalls and/or network segmentation) are in place.

For additional information on industrial security measures that may be implemented, please visit

<https://www.siemens.com/industrialsecurity>.

Siemens' products and solutions undergo continuous development to make them more secure. Siemens strongly recommends that product updates are applied as soon as they are available and that the latest product versions are used. Use of product versions that are no longer supported, and failure to apply the latest updates may increase customer's exposure to cyber threats.

To stay informed about product updates, subscribe to the Siemens Industrial Security RSS Feed under

<https://www.siemens.com/industrialsecurity>.

1.8 Transportation and storage

To guarantee sufficient protection during transport and storage, observe the following:

- Keep the original packaging for subsequent transportation.
- Devices/replacement parts should be returned in their original packaging.
- If the original packaging is no longer available, ensure that all shipments are properly packaged to provide sufficient protection during transport. Siemens cannot assume liability for any costs associated with transportation damages.

NOTICE

Insufficient protection during storage

The packaging only provides limited protection against moisture and infiltration.

- Provide additional packaging as necessary.

Special conditions for storage and transportation of the device are listed in Technical data (Page 47).

1.9 Notes on warranty

The contents of this manual shall not become part of or modify any prior or existing agreement, commitment or legal relationship. The sales contract contains all obligations on the part of Siemens as well as the complete and solely applicable warranty conditions. Any statements regarding device versions described in the manual do not create new warranties or modify the existing warranty.

The content reflects the technical status at the time of publishing. Siemens reserves the right to make technical changes in the course of further development.









Safety notes

2.1 Preconditions for use

This device left the factory in good working condition. In order to maintain this status and to ensure safe operation of the device, observe these instructions and all the specifications relevant to safety.

Observe the information and symbols on the device. Do not remove any information or symbols from the device. Always keep the information and symbols in a completely legible state.

2.1.1 Warning symbols on the device

Symbol	Explanation
	Consult operating instructions
	Hot surface
	Dangerous electrical voltage
	Corrosive materials
	Toxic materials
	Isolate the device from power using a circuit-breaker
	Protect the device from impact otherwise loss of degree of protection
	Protective insulation; device in protection class II

Observe the safety rules, provisions and laws applicable in your country during connection, assembly and operation. These include, for example:

- National Electrical Code (NEC - NFPA 70) (USA)
- Canadian Electrical Code (CEC) (Canada)

2.1 Preconditions for use

Further provisions for hazardous area applications are for example:

- IEC 60079-14 (international)
- EN 60079-14 (EU)

Observe the test certification, provisions and laws applicable in your country during connection, assembly and operation. These include, for example:

- National Electrical Code (NEC - NFPA 70) (USA)
- Canadian Electrical Code (CEC) (Canada)

Further provisions for hazardous area applications are for example:

- IEC 60079-14 (international)
- EN 60079-14 (EU)
- For Korea only:
이 기기는 업무용(A 급) 전자파 적합기기로서 판매자
또는 사용자는 이 점을 주의하시기 바라며 가정 외의

지역에서 사용하는 것을 목적으로 합니다

2.1.2 Conformity with European directives

The CE marking on the device symbolizes the conformity with the following European directives:

Electromagnetic compatibility EMC 2014/30/EU	Directive of the European Parliament and of the Council on the harmonisation of the laws of the Member States relating to electromagnetic compatibility
Low voltage directive LVD 2014/35/EU	Directive of the European Parliament and of the Council on the harmonisation of the laws of the Member States relating to the making available on the market of electrical equipment designed for use within certain voltage limits
Atmosphère explosible ATEX 2014/34/EU	Directive of the European Parliament and the Council on the harmonisation of the laws of the Member States relating to equipment and protective systems intended for use in potentially explosive atmospheres
Pressure equipment directive PED 2014/68/EU	Directive of the European Parliament and of the Council on the harmonisation of the laws of the Member States relating to the making available on the market of pressure equipment
2011/65/EU RoHS	Directive of the European Parliament and the Council on the restriction of the use of certain hazardous substances in electrical and electronic equipment

The applicable directives can be found in the EU declaration of conformity of the specific device.

 WARNING
Improper device modifications
Risk to personnel, system and environment can result from modifications to the device, particularly in hazardous areas.
<ul style="list-style-type: none">• Only carry out modifications that are described in the instructions for the device. Failure to observe this requirement cancels the manufacturer's warranty and the product approvals.

2.2 Requirements for special applications

Due to the large number of possible applications, each detail of the described device versions for each possible scenario during commissioning, operation, maintenance or operation in systems cannot be considered in the instructions. If you need additional information not covered by these instructions, contact your local Siemens office or company representative.

Note

Operation under special ambient conditions

We highly recommend that you contact your Siemens representative or our application department before you operate the device under special ambient conditions as can be encountered in nuclear power plants or when the device is used for research and development purposes.

2.3 Use in hazardous areas

Special conditions for safe use

In general, it is required that:

- EN/IEC 60079-14 is considered for installation in hazardous areas.
- Appropriate cable connectors are used.
- Sensor is connected to the potential equalization throughout the hazardous area.
- The device is not opened when energized and when an explosive gas or dust atmosphere may be present.

2.3 Use in hazardous areas

Further information and instructions including approval-specific special conditions for safe use in Ex applications can be found in the certificates on the documentation disk and at the product web page (www.siemens.com/FC310).

 WARNING
Substitution of components
Substitution of components may impair Intrinsic Safety.

 WARNING
Laying of cables
Risk of explosion in hazardous areas.
Cable for use in hazardous areas must satisfy the requirements for having a proof voltage of at least 500 V AC applied between the conductor/ground, conductor/shield and shield/ground.
Connect the devices that are operated in hazardous areas as per the stipulations applicable in the country of operation.

 WARNING
Field wiring installation
Ensure that the national requirements of the country in which the devices are installed are met.

Qualified personnel for hazardous area applications

Persons who install, connect, commission, operate, and service the device in a hazardous area must have the following specific qualifications:

- They are authorized, trained or instructed in operating and maintaining devices and systems according to the safety regulations for electrical circuits, high pressures, aggressive, and hazardous media.
- They are authorized, trained, or instructed in carrying out work on electrical circuits for hazardous systems.
- They are trained or instructed in maintenance and use of appropriate safety equipment according to the pertinent safety regulations.

 WARNING
Use in hazardous area
Risk of explosion.
<ul style="list-style-type: none">• Only use equipment that is approved for use in the intended hazardous area and labeled accordingly.• Do not use devices that have been operated outside the conditions specified for hazardous areas. If you have used the device outside the conditions for hazardous areas, make all Ex markings unrecognizable on the nameplate.

See also

Technical data (Page 47)

 WARNING
Loss of safety of device with type of protection "Intrinsic safety Ex i"
<p>If the device or its components have already been operated in non-intrinsically safe circuits or the electrical specifications have not been observed, the safety of the device is no longer ensured for use in hazardous areas. There is a risk of explosion.</p> <ul style="list-style-type: none">• Connect the device with type of protection "Intrinsic safety" solely to an intrinsically safe circuit.• Observe the specifications for the electrical data on the certificate and/or in Technical data (Page 47).

2.3 Use in hazardous areas

Installing/mounting

3.1 Basic safety notes

 WARNING
Wetted parts unsuitable for the process media Risk of injury or damage to device. Hot, toxic and corrosive media could be released if the wetted parts are unsuitable for the process medium. <ul style="list-style-type: none">• Ensure that the material of the device parts wetted by the process medium is suitable for the medium. Refer to the information in Technical data (Page 47).

Note**Material compatibility**

Siemens can provide you with support concerning selection of sensor components wetted by process media. However, you are responsible for the selection of components. Siemens accepts no liability for faults or failures resulting from incompatible materials.

 WARNING
Unsuitable connecting parts Risk of injury or poisoning. In case of improper mounting, hot, toxic, and corrosive process media could be released at the connections. <ul style="list-style-type: none">• Ensure that connecting parts (such as flange gaskets and bolts) are suitable for connection and process media.

See also

Technical data (Page 47)

 WARNING
Exceeded maximum permissible operating pressure
Risk of injury or poisoning.
The maximum permissible operating pressure depends on the device version, pressure limit and temperature rating. The device can be damaged if the operating pressure is exceeded. Hot, toxic and corrosive process media could be released.
Ensure that maximum permissible operating pressure of the device is not exceeded. Refer to the information on the nameplate and/or in Technical data (Page 47).

 CAUTION
Hot surfaces resulting from hot process media
Risk of burns resulting from surface temperatures above 65 °C (149 °F).
<ul style="list-style-type: none">• Take appropriate protective measures, for example contact protection.• Make sure that protective measures do not cause the maximum permissible ambient temperature to be exceeded. Refer to the information in Technical data (Page 47).

 CAUTION
External stresses and loads
Damage to device by severe external stresses and loads (e.g. thermal expansion or pipe tension). Process media can be released.
<ul style="list-style-type: none">• Prevent severe external stresses and loads from acting on the device.

3.1.1 Installation location requirements

 WARNING
Insufficient air supply
The device may overheat if there is an insufficient supply of air.
<ul style="list-style-type: none">• Install the device so that there is sufficient air supply in the room.• Observe the maximum permissible ambient temperature. Refer to the information in the section Technical data (Page 47).

NOTICE
Aggressive atmospheres Damage to device through penetration of aggressive vapors. <ul style="list-style-type: none">• Ensure that the device is suitable for the application.

NOTICE
Direct sunlight Device damage. The device can overheat or materials become brittle due to UV exposure. <ul style="list-style-type: none">• Protect the device from direct sunlight.• Make sure that the maximum permissible ambient temperature is not exceeded. Refer to the information in Technical data (Page 47).

NOTICE
Strong vibrations Damage to device. <ul style="list-style-type: none">• In installations with strong vibrations, mount the transmitter in a low vibration environment.

3.1.2 Proper mounting

 WARNING
Incorrect mounting at Zone 0 Risk of explosion in hazardous areas. <ul style="list-style-type: none">• Ensure sufficient tightness at the process connection.• Observe the standard IEC/EN 60079-14.

 WARNING
Loss of type of protection Risk of explosion. Damage to device if the enclosure is open or not properly closed. The type of protection specified on the nameplate or in Technical data (Page 47) is no longer guaranteed. <ul style="list-style-type: none">• Make sure that the device is securely closed.

NOTICE
Incorrect mounting
The device can be damaged, destroyed, or its functionality impaired through improper mounting.
<ul style="list-style-type: none">• Before installing ensure there is no visible damage to the device.• Make sure that process connectors are clean, and suitable gaskets and glands are used.• Mount the device using suitable tools. Refer to the information in Technical data (Page 47).

3.2 Installation instructions

 CAUTION
Electromagnetic fields
Do not install the flowmeter in the vicinity of strong electromagnetic fields, for example near motors, variable frequency drives, transformers etc.

Upstream / downstream

- No pipe run requirements, that is straight inlet/outlet sections, are necessary.
- Avoid long drop lines downstream from the sensor to prevent process media separation causing air / vapor bubbles in the tube (min. back pressure: 0.2 bar).
- Avoid installing the flowmeter immediately upstream of a free discharge in a drop line.

Location in the system

The optimum location in the system depends on the application:

- Liquid applications
Gas or vapor bubbles in the fluid may result in erroneous measurements, particularly in the density measurement.
 - Do not install the flowmeter at the highest point in the system, where bubbles will be trapped.
 - Install the flowmeter in low pipeline sections, at the bottom of a U-section in the pipeline.

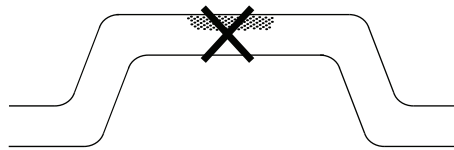

Figure 3-1 Liquid applications, wrong location with trapped air/gas

- Gas applications
Vapor condensation or oil traces in the gas may result in erroneous measurements.
 - Do not install the flowmeter at the lowest point of the system.
 - Install a filter.

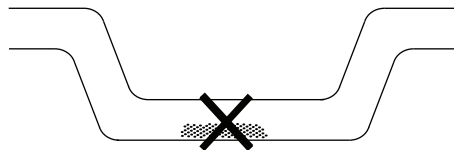

Figure 3-2 Gas applications, wrong location with trapped oil

3.2.1 Orientation of the sensor

Flow direction

The calibrated flow direction is indicated by the arrow on the sensor. Flow in this direction will be indicated as positive by default. The sensitivity and the accuracy of the sensor do not change with reverse flow.

The indicated flow direction (positive/negative) is configurable.

CAUTION

Accurate measurement

The sensor must always be completely filled with process media in order to measure accurately.

NOTICE
Orienting the sensor
To avoid water or moist ingress, transmitters should be oriented with cable entrances aiming downwards.

Orienting the sensor

The sensor operates in any orientation. The optimal orientation depends on the process fluid and the process conditions. Siemens recommends orienting the sensor in one of the following ways:

1. Vertical installation with an upwards flow (self-draining)

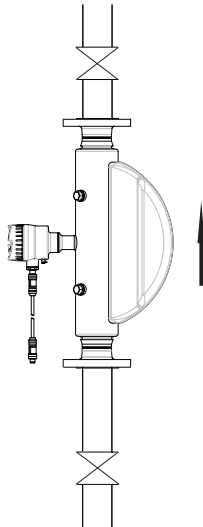

Figure 3-3 Vertical orientation, upwards flow

2. Horizontal installation, tubes down (recommended for liquid applications)

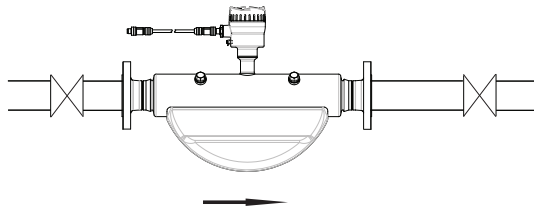

Figure 3-4 Horizontal orientation, tubes down

3. Horizontal installation, tubes up (recommended for gas applications)

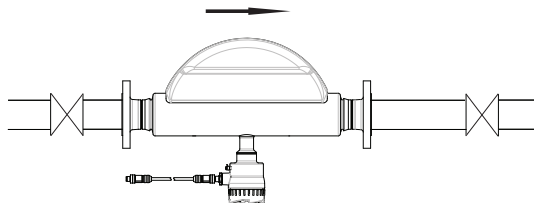

Figure 3-5 Horizontal orientation; tubes up

Note

Hygienic applications

In EHEDG certified applications the flowmeter must be installed vertically as shown in 1 above. (*EHEDG certificate in preparation*)

3.3 Disassembly

Installation in a drop line is only recommended if a pipeline reduction or orifice with a smaller cross-section can be installed to create back-pressure and prevent the sensor from being partially drained while measuring.

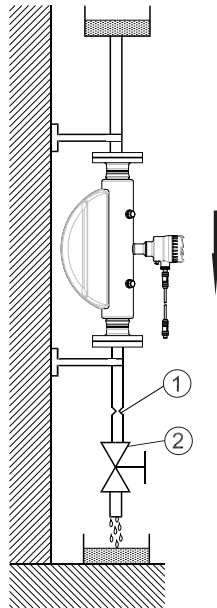

- ① Back pressure orifice
- ② On / off valve

Figure 3-6 Installation in drop line

3.3 Disassembly

<p>⚠ WARNING</p> <p>Incorrect disassembly</p> <p>The following risks may result from incorrect disassembly:</p> <ul style="list-style-type: none">- Injury through electric shock- Risk through emerging media when connected to the process- Risk of explosion in hazardous area <p>In order to disassemble correctly, observe the following:</p> <ul style="list-style-type: none">• Before starting work, make sure that you have switched off all physical variables such as pressure, temperature, electricity etc. or that they have a harmless value.• If the device contains hazardous media, it must be emptied prior to disassembly. Make sure that no environmentally hazardous media are released.• Secure the remaining connections so that no damage can result if the process is started unintentionally.
--

Connecting

4.1 Basic safety notes

 WARNING
Unsuitable cables, cable glands and/or plugs Risk of explosion in hazardous areas. <ul style="list-style-type: none">• Use only cable glands/plugs that comply with the requirements for the relevant type of protection.• Tighten the cable glands in accordance with the torques specified in Technical data (Page 47).• Close unused cable inlets for the electrical connections.• When replacing cable glands, only use cable glands of the same type.• After installation, check that the cables are seated firmly.

 WARNING
Incorrect conduit system Risk of explosion in hazardous areas as result of open cable inlet or incorrect conduit system. <ul style="list-style-type: none">• In the case of a conduit system, mount a spark barrier at a defined distance from the device input. Observe national regulations and the requirements stated in the relevant approvals.

See also

Technical data (Page 47)

 WARNING
Hazardous contact voltage Risk of electric shock in case of incorrect connection. <ul style="list-style-type: none">• For the electrical connection specifications, refer to the information in Technical data (Page 47).• At the mounting location of the device observe the applicable directives and laws for installation of electrical power installations with rated voltages below 1000 V.

 WARNING
Missing PE/ground connection
Risk of electric shock.
Depending on the device version, connect the power supply as follows:
<ul style="list-style-type: none">• Power plug: Ensure that the used socket has a PE/ground conductor connection. Check that the PE/ground conductor connection of the socket and power plug match each other.• Connecting terminals: Connect the terminals according to the terminal connection diagram. First connect the PE/ground conductor.

 WARNING
Improper power supply
Risk of explosion in hazardous areas as result of incorrect power supply.
<ul style="list-style-type: none">• Connect the device in accordance with the specified power supply and signal circuits. The relevant specifications can be found in the certificates, in Technical data (Page 47) or on the nameplate.

 WARNING
Lack of equipotential bonding
Risk of explosion through compensating currents or ignition currents through lack of equipotential bonding.
<ul style="list-style-type: none">• Ensure that the device is potentially equalized.
Exception: It may be permissible to omit connection of the equipotential bonding for devices with type of protection "Intrinsic safety Ex i".

 WARNING
Unprotected cable ends
Risk of explosion through unprotected cable ends in hazardous areas.
<ul style="list-style-type: none">• Protect unused cable ends in accordance with IEC/EN 60079-14.

 WARNING
Improper laying of shielded cables
Risk of explosion through compensating currents between hazardous area and the non-hazardous area.
<ul style="list-style-type: none">• Shielded cables that cross into hazardous areas should be grounded only at one end.• If grounding is required at both ends, use an equipotential bonding conductor.

 **WARNING****Uncovered non-intrinsically safe circuits**

Risk of explosion in hazardous areas or electric shock when working on non-intrinsically safe circuits.

If intrinsically safe and non-intrinsically safe circuits are operated in an enclosure with the type of protection "Increased safety Ex e", the connections of the non-intrinsically safe circuits must be additionally covered.

- Ensure that the cover of the non-intrinsically safe circuits complies with degree of protection IP30 or higher according to IEC/EN 60529.
- Separate connections of the non-intrinsically safe circuits in accordance with IEC/EN 60079-14.

 **WARNING****Insufficient isolation of intrinsically safe and non-intrinsically safe circuits**

Risk of explosion in hazardous areas.

- When connecting intrinsically safe and non-intrinsically safe circuits ensure that isolation is carried out properly in accordance with local regulations for example IEC 60079-14.
- Ensure that you observe the device approvals applicable in your country.

 **WARNING****Connecting device in energized state**

Risk of explosion in hazardous areas.

- Connect devices in hazardous areas only in a de-energized state.

Exceptions:

- Devices having the type of protection "Intrinsic safety Ex i" may also be connected in energized state in hazardous areas.
- Exceptions for type of protection "Increased safety ec" (Zone 2) are regulated in the relevant certificate.

 **WARNING****Incorrect selection of type of protection**

Risk of explosion in areas subject to explosion hazard.

This device is approved for several types of protection.

1. Decide in favor of one type of protection.
2. Connect the device in accordance with the selected type of protection.
3. In order to avoid incorrect use at a later point, make the types of protection that are not used permanently unrecognizable on the nameplate.

NOTICE

Ambient temperature too high

Damage to cable sheath.

- At an ambient temperature $\geq 60\text{ }^{\circ}\text{C}$ ($140\text{ }^{\circ}\text{F}$), use heat-resistant cables suitable for an ambient temperature at least $20\text{ }^{\circ}\text{C}$ ($36\text{ }^{\circ}\text{F}$) higher.

NOTICE

Condensation in the device

Damage to device through formation of condensation if the temperature difference between transportation or storage and the mounting location exceeds $20\text{ }^{\circ}\text{C}$ ($36\text{ }^{\circ}\text{F}$).

- Before taking the device into operation, let the device adapt for several hours in the new environment.

Note

Electromagnetic compatibility (EMC)

You can use this device in industrial environments, households and small businesses.

For metal housings there is an increased electromagnetic compatibility compared to high-frequency radiation. This protection can be increased by grounding the housing, see Connecting (Page 27).

Note

Improvement of interference immunity

- Lay signal cables separate from cables with voltages $> 60\text{ V}$.
 - Use cables with twisted wires.
 - Keep device and cables at a distance from strong electromagnetic fields.
 - Take account of the conditions for communication specified in the Technical data (Page 47).
 - Use shielded cables to guarantee the full specification according to HART/PA/FF/Modbus/EIA-485/Profibus DP.
-

4.2 Connecting the FC310

4.2.1 Warnings

 WARNING
Improper handling
The sensor connected to this device can be operated with high pressure and corrosive media. Therefore improper handling of the device can lead to serious injuries and/or considerable material damage.

Cablespecifications

- Only use cables with at least the same degree of protection as the sensor to install the sensor. It is recommended to use cables supplied by Siemens S.A.S., Flow Instruments.
- Siemens supplied cables can be ordered with M12 plug on both ends or without plug.
- To guarantee the IP67 degree of protection, ensure that both ends of the cables are given equivalent protection from ingress of moisture.
- For further information on Siemens-supplied cables, see Technical Data (Page 47).

 WARNING
Cable requirements
Cables must be suitable for the temperature (at least 70 °C) and be flammability-rated to at least V-2.

Note

End Of Line (EOL) termination

The FCT010 EOL termination DIP switch is default set to EOL active. To change termination setting see Warnings (Page 31).

It is important to terminate the Modbus RS-485 line correctly at the start and end of the bus segment. Impedance mismatch results in reflections on the line which can cause faulty communication transmission.

If the device is at the end of the bus segment, it is recommended to terminate the device. The following table shows the relation between the DIP switch settings and the permissible communication interface set-ups. Default configuration is EOL active.

Location of DIP switch

The DIP switch is located in the electronic as shown below.

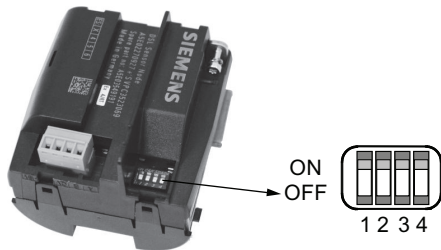

Figure 4-1 DIP switch location (all set to ON)

DIP switch settings for communication set-up

DIP switch Communication set-up	Switch 1	Switch 2	Switch 3	Switch 4
EOL active	On	On	On	On
EOL not active	On	On	Off	Off

NOTICE

Avoid DIP switch settings not mentioned in the table

DIP switch settings not mentioned in the table preceding are not allowed and may reduce communication interface reliability.

A: Prepare the cable by stripping it at both ends.

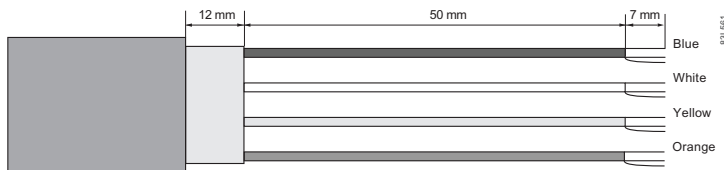

Figure 4-2 Cable end

B: Connect wires within the sensor terminal compartment

1. Remove the lock screw and remove the lid.
2. Undo the flexible strap.
3. Disconnect the sensor connection (white plug) from the electronic.
4. Loosen the mounting screw using a TX10 Torx driver and remove the electronic from the housing.
5. Remove the cap and the ferrule from the cable gland and slide onto the cable.
6. Push the cable through the open gland and anchor the cable shield and the wires with the clamp bar.
7. Remove the terminal block from the electronic.

8. Connect the wires to the terminals according to the list below.

Terminal number	Description	Wire color (Siemens cable)
1	0+	Orange
2	0 V	Yellow
3	RS-485 / B	White
4	RS-485 / A	Blue

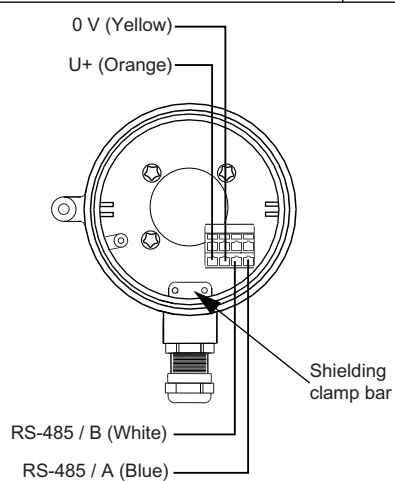
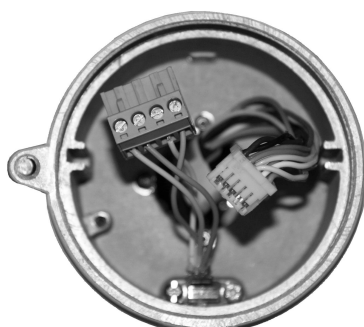
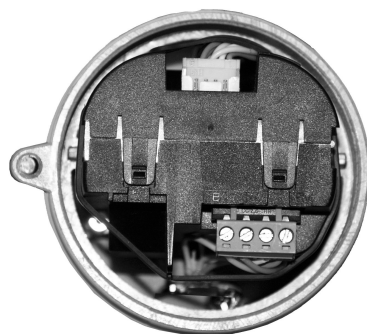

Figure 4-3 Sensor terminal compartment



9. Reinstall the electronic including the mounting screw.
10. Connect the sensor connection and the sensor cable.
11. Restore the flexible strap around all wires.



4.2 Connecting the FC310

12. Assemble and tighten the cable gland.
13. Remove the O-ring from lid.
14. Reinstall the lid and screw in until the mechanical stop. Wind back the lid by one turn.
15. Mount the O-ring by pulling it over the lid and tighten the lid until you feel friction from the O-ring on both sides. Wind the lid by one quarter of a turn to seal on the O-ring.
16. Reinstall and tighten the lid lock screw.

Commissioning

5.1 Basic safety notes

DANGER

Toxic gases and liquids

Danger of poisoning when venting the device: if toxic process media are measured, toxic gases and liquids can be released.

- Before venting ensure that there are no toxic gases or liquids in the device, or take the appropriate safety measures.

WARNING

Improper commissioning in hazardous areas

Device failure or risk of explosion in hazardous areas.

- Do not commission the device until it has been mounted completely and connected in accordance with the information in Installing/mounting (Page 19).
- Before commissioning take the effect on other devices in the system into account.

WARNING

Commissioning and operation with pending error

If an error message appears, correct operation in the process is no longer guaranteed.

- Check the gravity of the error.
- Correct the error.
- If the error still exists:
 - Take the device out of operation.
 - Prevent renewed commissioning.

WARNING

Hot surfaces

Risk of burns resulting from hot surfaces.

- Take corresponding protective measures, for example by wearing protective gloves.

 WARNING
Hazardous contact voltage
Risk of injury through hazardous contact voltage when the device is open or not completely closed.
The degree of protection specified on the nameplate or in Technical data (Page 47) is no longer guaranteed if the device is open or not properly closed.
<ul style="list-style-type: none">• Make sure that the device is securely closed.

 WARNING
Loss of explosion protection
Risk of explosion in hazardous areas if the device is open or not properly closed.
<ul style="list-style-type: none">• Close the device as described in Installing/mounting (Page 19).

 WARNING
Opening device in energized state
Risk of explosion in hazardous areas
<ul style="list-style-type: none">• Only open the device in a de-energized state.• Check prior to commissioning that the cover, cover locks, and cable inlets are assembled in accordance with the directives.
Exception: Devices having the type of protection "Intrinsic safety Ex i" may also be opened in energized state in hazardous areas.

 WARNING
Hazardous gases in the enclosure
Risk of explosion.
Hazardous gases are gases that can explode and have a gas concentration of more than 25% of the lower explosion limit (LEL). Under normal ambient conditions the LEL is the risk threshold when handling these gases. However, special operating conditions can lower the potential risk from these gases under the LEL. A value of 25% of the LEL is regarded as definitely safe.
<ul style="list-style-type: none">• Do not introduce combustible or hazardous gases into a restricted-breathing enclosure (type of protection Ex nR).

 **WARNING**

Dust in pressurized enclosure "Type of protection Ex p"

An explosive dust atmosphere inside an enclosure can result in an explosion.

- In Zones 21 and 22: Remove the dust layers manually from the enclosure.
- Cleaning by pre-purging is not permitted.

 **WARNING**

Loss of type of protection

Risk of explosion. Damage to device if the enclosure is open or not properly closed. The type of protection specified on the nameplate or in Technical data (Page 47) is no longer guaranteed.

- Make sure that the device is securely closed.

Service and maintenance

6.1 Basic safety notes

Note

The device is maintenance-free.

The device is maintenance-free. However, a periodic inspection according to pertinent directives and regulations must be carried out.

An inspection can include, for example, check of:

- Ambient conditions
- Seal integrity of the process connections, cable entries, and cover
- Reliability of power supply, lightning protection, and grounds

WARNING

Dust layers above 5 mm

Risk of explosion in hazardous areas.

Device may overheat due to dust build up.

- Remove dust layers in excess of 5 mm.

WARNING

Leaks in the sample gas path

Risk of poisoning.

When measuring toxic process media, these can be released or collect in the device if there are leaks in the sample gas path.

- Purge the device as described in Commissioning (Page 35).
- Dispose of the toxic process media displaced by purging in an environmentally friendly manner.

WARNING

Use of a computer in a hazardous area

If the interface to the computer is used in the hazardous area, there is a risk of explosion.

- Ensure that the atmosphere is explosion-free (hot work permit).

 CAUTION
Releasing button lock Improper modification of parameters could influence process safety. <ul style="list-style-type: none">• Make sure that only authorized personnel may cancel the button locking of devices for safety-related applications.

NOTICE
Penetration of moisture into the device Device damage. <ul style="list-style-type: none">• Make sure when carrying out cleaning and maintenance work that no moisture penetrates the inside of the device.

6.2 Cleaning

Cleaning the enclosure

- Clean the outside of the enclosure with the inscriptions and the display window using a cloth moistened with water or a mild detergent.
- Do not use any aggressive cleansing agents or solvents, e.g. acetone. Plastic parts or the painted surface could be damaged. The inscriptions could become unreadable.

 WARNING
Electrostatic charge Risk of explosion in hazardous areas if electrostatic charges develop, for example, when cleaning plastic surfaces with a dry cloth. <ul style="list-style-type: none">• Prevent electrostatic charging in hazardous areas.

NOTICE
Improper cleaning of diaphragm Device damage. The diaphragm can be damaged. <ul style="list-style-type: none">• Do not use sharp or hard objects to clean the diaphragm.

6.3 Maintenance and repair work

 WARNING
Impermissible repair of the device <ul style="list-style-type: none">• Repair must be carried out by Siemens authorized personnel only.

 WARNING
Impermissible repair and maintenance of the device <ul style="list-style-type: none">• Repair and maintenance must be carried out by Siemens authorized personnel only.

 WARNING
Impermissible repair of explosion protected devices <p>Risk of explosion in hazardous areas</p> <ul style="list-style-type: none">• Repair must be carried out by Siemens authorized personnel only.

 WARNING
Maintenance during continued operation in a hazardous area <p>There is a risk of explosion when carrying out repairs and maintenance on the device in a hazardous area.</p> <ul style="list-style-type: none">• Isolate the device from power. <p>- or -</p> <ul style="list-style-type: none">• Ensure that the atmosphere is explosion-free (hot work permit).

 WARNING
Impermissible accessories and spare parts <p>Risk of explosion in areas subject to explosion hazard.</p> <ul style="list-style-type: none">• Only use original accessories or original spare parts.• Observe all relevant installation and safety instructions described in the instructions for the device or enclosed with the accessory or spare part.

 WARNING
Humid environment
Risk of electric shock.
<ul style="list-style-type: none">• Avoid working on the device when it is energized.• If working on an energized device is necessary, ensure that the environment is dry.• Make sure when carrying out cleaning and maintenance work that no moisture penetrates the inside of the device.

 WARNING
Enclosure open
Risk of explosion in hazardous areas as a result of hot components and/or charged capacitors inside the device.
To open the device in a hazardous area:
<ol style="list-style-type: none">1. Isolate the device from power.2. Observe the wait time specified in Technical data (Page 47) or on the warning sign before opening the device.3. Visually inspect sensor inlet and outlet.
Exception: Devices exclusively having the type of protection "Intrinsic safety Ex i" may be opened in an energized state in hazardous areas.

 WARNING
Improper connection after maintenance
Risk of explosion in areas subject to explosion hazard.
<ul style="list-style-type: none">• Connect the device correctly after maintenance.• Close the device after maintenance work.
Refer to Technical data (Page 47).

 WARNING
Hot, toxic or corrosive process media
Risk of injury during maintenance work.
When working on the process connection, hot, toxic or corrosive process media could be released.
<ul style="list-style-type: none">• As long as the device is under pressure, do not loosen process connections and do not remove any parts that are pressurized.• Before opening or removing the device ensure that process media cannot be released.

⚠ CAUTION**Hot surfaces**

Risk of burns during maintenance work on parts having surface temperatures exceeding 70 °C (158 °F).

- Take corresponding protective measures, for example by wearing protective gloves.
- After carrying out maintenance, remount touch protection measures.

⚠ CAUTION**Hot parts in the device**

Temperatures that can burn unprotected skin may be present for some time after the device has been switched off.

- Observe the waiting time specified in Technical data (Page 47) or on the device before starting with maintenance work.

6.3.1 Ex-approved products

Note**Repair of Ex-approved products**

It is the customer's responsibility that repair of Ex-approved products fulfill national requirements.

⚠ CAUTION**Hazardous voltage at open device**

Risk of electric shock when the enclosure is opened or enclosure parts are removed.

- Before you open the enclosure or remove enclosure parts, de-energize the device.
- If maintenance measures in an energized state are necessary, observe the particular precautionary measures. Have maintenance work carried out by qualified personnel.

6.4 Replacing the device

 CAUTION
Corrosive substances
Risk of chemical burns when replacing the sensor.
The sensor in the device contains corrosive substances that result in burns on unprotected skin.
<ul style="list-style-type: none">• Make sure that the sensor enclosure is not damaged when replacing the sensor.• If contact with the corrosive substances occurs, rinse the affected skin immediately with large amount of water to dilute substance.

6.5 Return procedure

Enclose the bill of lading, return document and decontamination certificate in a clear plastic pouch and attach it firmly to the outside of the packaging.

Required forms

- Delivery note
- Return goods delivery note (<http://www.siemens.com/processinstrumentation/returngoodsnote>)
with the following information:
 - Product (item description)
 - Number of returned devices/replacement parts
 - Reason for returning the item(s)
- Decontamination declaration (<http://www.siemens.com/sc/declarationofdecontamination>)
With this declaration you warrant "that the device/replacement part has been carefully cleaned and is free of residues. The device/replacement part does not pose a hazard for humans and the environment."
If the returned device/replacement part has come into contact with poisonous, corrosive, flammable or water-contaminating substances, you must thoroughly clean and decontaminate the device/replacement part before returning it in order to ensure that all hollow areas are free from hazardous substances. Check the item after it has been cleaned. Any devices/replacement parts returned without a decontamination declaration will be cleaned at your expense before further processing.

6.6 Disposal

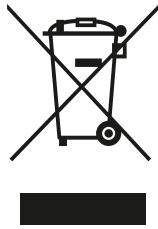

Devices described in this manual should be recycled. They may not be disposed of in the municipal waste disposal services according to the Directive 2012/19/EC on waste electronic and electrical equipment (WEEE).

Devices can be returned to the supplier within the EC, or to a locally approved disposal service for eco-friendly recycling. Observe the specific regulations valid in your country.

Further information about devices containing batteries can be found at: Information about battery / product return (WEEE) (<https://support.industry.siemens.com/cs/document/109479891/>)

Note

Special disposal required

The device includes components that require special disposal.

- Dispose of the device properly and environmentally through a local waste disposal contractor.
-

Technical data

Table 7-1 Power supply

Description	Specification
Supply Voltage [V]	12 - 27 VDC Um: 60 VDC
Reverse polarity protection	Yes
Power consumption	1.1 W

Intrinsically Safe specification: Ui: 20 V, Ii: 484 mA, Pi: 2.3 W, Li: 0.6 uH, Ci: 1.9 nF.

7.1 Modbus Communication Specification

Table 7-2 Modbus communication specification

Description	Specification
Device type	Slave
Baud rates	<ul style="list-style-type: none"> • 9600 • 19 200 (Factory setting) • 38 400 • 57 600 • 76 800 • 115 200
Number of stations	Max. 31 per segment without repeaters
Device address range	1 to 247
Protocol	Modbus RTU
Electrical interface	RS-485, 2-wire
Connector type	M12 / Cable termination
Supported function codes	<ul style="list-style-type: none"> • 3: read holding registers • 16: write multiple registers • 8: diagnostics
Broadcast	No ¹⁾
Maximum cable length [m]	600 meters (@ 115 200 bits/sec)
Standard	Modbus over serial line v 1.0 ²⁾
Certification	one
Device Profile	None

¹⁾: Standard restriction. The standard requires a LED indicator for visual diagnosis. This device does not support a LED indicator. This device does not react to any Broadcast commands.

²⁾: According to the Specification & Implementation guide v. 1.0 available at the Modbus Organization website

Note

Storage location

All Modbus settings of the device are stored in a non-volatile memory.

7.2 Operating conditions

Table 7-3 Basic conditions

Description	Specification
Ambient temperature (°C[°F]) Operation (Humidity max. 90 %)	-40 to +60 [-40 to +140]
Ambient temperature (°C[°F]) Storage (Humidity max. 90 %)	-40 to +70 [-40 to +158]
Climate class	DIN 60721-3-4
Altitude	Up to 2000 m (6560 ft)
Relative humidity [%]	95
EMC performance	EN/IEC 61326-1 (Industry)

Table 7-4 Process media conditions

Description	Specification
Process media temperature (T _s) (min to max) [°C (F)] • DIN11851/ SMS1145/ DIN32676	-10 to +140
Process media temperature (T _s) (min to max) [°C (F)] • DN15 - DN150	-50 up to +205 (-58 to +401)
Process media density (min to max) [kg/m ³ (lb/ft ³)]	1 to 5000 (0.06 to 312)
Pressure drop	See Siemens Sizing & Calculation tool (https://pia-portal.automation.siemens.com/SIE/Z3_PIA_PORTAL/~fINUQVRFPTlwNDg5LjAwMi4wMS4wMQ==?~okcode=EV_CAL). Select "Flow" and "SITRANS F C sizing".
Pressure temperature ratings	See Operating Instructions for FC310

7.3 Certificates and approvals

Specification	Ex marking ATEX/IECEx	Ex marking FM/CSA
Flameproof and Intrinsic Safety		
FCS300 and FC310 (can be installed in Zone 1 for gas)	<p>⊕ II 1/2 G Ex db ia IIC/IIB T* Ga/Gb</p> <p>⊕ II 1/2 G Ex db IIC/IIB T* Ga/Gb Ta = -40°C to **°C</p> <p>* Temperature class (dependent on the process temperature and the ambient temperature, see Special conditions for safe use (Page 15))</p>	<p>Ex db ia IIC/IIB T4-T3 Gb Ex db IIC/IIB T4-T3 Gb Ta = -40°C to +60°C</p> <p>Class I, Division 1 Gp A, B, C, D Class I, Zone 1, AEx db ia IIC T4-T3 Gb Ta = -40°C to +60°C</p>
Hygienic version	EHEDG (<i>in preparation</i>)	
Pressure equipment	<ul style="list-style-type: none"> • 2014/68/EU Pressure Equipment Directive (PED) • Canadian Registration Number (CRN) (<i>in preparation</i>) 	

Certificates and support

A.1 Technical support

Technical support

If this documentation does not provide complete answers to any technical questions you may have, contact Technical Support at:

- Support request (<http://www.siemens.com/automation/support-request>)
- More information about our Technical Support is available at Technical Support (<http://www.siemens.com/automation/csi/service>)

Internet Service & Support

In addition to our documentation, Siemens provides a comprehensive support solution at:

- Service & Support (<http://www.siemens.com/automation/service&support>)

Personal contact

If you have additional questions about the device, please contact your Siemens personal contact at:

- Partner (<http://www.automation.siemens.com/partner>)

To find the personal contact for your product, go to "All Products and Branches" and select "Products & Services > Industrial Automation > Process Instrumentation".

Documentation

You can find documentation on various products and systems at:

- Instructions and manuals (<http://www.siemens.com/processinstrumentation/documentation>)

A.2 Certificates

You can find certificates on the Internet at Industry online support portal (<http://www.siemens.com/processinstrumentation/certificates>) or on an included DVD.

Index

A

Approval nameplate, 9

C

Cable specifications, 31
Certificates, 13, 14, 51
Certificates and approvals, 49
Cleaning, 40
Compact Operating Instructions, 51
Customer Support, (Refer to Technical support)

D

Device
 Identification, 5
Disassembly, 26
Disposal, 45
Document history, 5
Documentation, 51
 Edition, 5

E

Electrical connection
 Cable specifications, 31

F

Flow direction, 23

H

Hazardous area
 Laws and directives, 14
 Qualified personnel, 16
Hotline, (Refer to Support request)

I

Identification nameplate, 6
 Sensor, 6
Installation
 Gas, 23

Inlet / Outlet conditions, 22
 Liquid, 23
 Location in the system, 22
 Orienting the sensor, 25
 Upstream / Downstream, 22
Instructions and manuals, 51

L

Laws and directives
 Disassembly, 14
 Personell, 14

M

Maintenance, 39
Manuals, 51
Modbus
 Technical data, 47
Modifications
 correct usage, 15
 improper, 15

O

Operating Instructions, 51

P

Power supply, 47

Q

Qualified personnel, 16

R

Rated operating conditions, 48
Return procedure, 44

S

Scope of delivery, 10
Sensor orientation, (See Installation)
Service, 51

Service & Support, 51
 Internet, 51
Specification nameplate, 8
Support, 51
Support request, 51
Symbols, (Refer to warning symbols)

T

Technical support, 51
 Partner, 51
 Personal contact, 51
Termination DIP switches, 31
Test certificates, 13, 14

W

Warning symbols, 13
Warranty, 11